

Data sheet

Commercial Art.No.: 72.310.0653.0

Male insert BAS STS 6 2,5 69

Male insert revos basic, 6-poles, rated current: 16A, rated voltage: 690V, with tinned contacts



Commercial Art.No.	72.310.0653.0
EAN	4015573227231
Order Unit	10

Certificates / Approvals



Technical data

General

Model	Pin insert
Inflammability class of insulation material acc. with UL94	V0
Color	Grey
Mating cycles	200
Pollution degree	3
Modular version	No
Operating temperature range min.	-40 °C
Operating temperature range max.	120 °C

Connection Data

Connection type	screw connection
Number of poles	4
Plus switching contacts	2
Number of pole for rated current 2	0
Number of pole for rated current 3	0
Total number of poles (without ground contact)	6
With wire protection	yes
Min. conductor diameter rigid (solid/stranded)	0.5 mm ²
Max. conductor diameter rigid (solid/stranded)	2.5 mm ²
Protective contact	yes

Technical Data UL/CSA

Rated voltage according to UL/CSA	600 V
Rated current according UL	5 A
Rated current according CSA	16 A

Min. conductor cross section flexible wire	0.5 mm ²
Max. conductor cross section flexible wire	2.5 mm ²
Conductor cross section flexible AWG wire	22-12 AWG

Model

With housing	No
--------------	----

Contacts

Contact material	Copper alloy
Surface	Tin-plated
Contact resistance	≤ 1.5 mOhm
Wire strip length	7 mm

Screws head design/recomm. Torque

Mounting screws	H1/0.5-0.7 Nm
Clamping screws	H1/0.5-0.7 Nm
Ground conductor screws	H2/1.2-1.6 Nm

Technical Data DIN EN 61984

Nominal voltage	690 V
Rated voltage face/ground	690 V
Nominal current	16 A
Rated impulse voltage	8 kV

Classification

ECLASS 11	
ECLASS 8.1	27440205
ETIM 7.0	EC000438
ETIM 6.0	EC000438
ETIM 5.0	EC000438
ETIM 4.0	EC000438
ETIM 3.0	EC000438

Product compliance

ROHS conformity status	Compliant/Exempted
ROHS exceptions	III-6(c)
REACH-SVHC conformity status	Duty-To-Declare
REACH-SVHC substances	Lead
REACH-SVHC CAS numbers	7439-92-1

Fits with

Commercial Art.No.:	Article-type description:	Description:
72.700.0658.0	Female insert BAS BUC 6 69	Female insert revos basic, 6-poles, rated current: 16A, rated voltage: 690V, with tin-plated contacts
70.350.0635.0	Hood BAS GOT GG 6 M20 A0	Hood revos basic made of aluminum, for single locking lever with cable gland M20 on the right side (IP54), low version, 6-poles

70.350.0635.1	Hood BAS GOT GG 6 M20 A1	Hood revos basic made of aluminum, for single locking lever with threaded hole M20 on the right side, low version, 6-poles
70.350.0635.2	Hood BAS GOT GG 6 M20 A2	Hood revos basic made of aluminum, for single locking lever with nozzleM20 on the right side, low version, 6-poles
70.350.0635.3	Hood BAS GOT GG 6 M20 A3	Hood revos basic made of aluminum, for single locking lever with trumpet gland M20 on the right side (IP54), low version, 6-poles
70.352.0635.0	Hood BAS GOT GI 6 M20 A0	Hood revos basic made of aluminum, for single locking lever with cable gland M20 on the top (IP54), low version, 6-poles
70.352.0635.1	Hood BAS GOT GI 6 M20 A1	Hood revos basic made of aluminum, for single locking lever with threaded hole M20 on the top, low version, 6-poles
70.352.0635.2	Hood BAS GOT GI 6 M20 A2	Hood revos basic made of aluminum, for single locking lever with nozzleM20 on the top, low version, 6-poles
70.352.0635.3	Hood BAS GOT GI 6 M20 A3	Hood revos basic made of aluminum, for single locking lever with trumpet gland M20 on the top (IP54), low version, 6-poles
70.353.0635.0	Hood BAS GOT GG 6 M25 A0	Hood revos basic made of aluminum, for single locking lever with cable gland M25 on the right side (IP54), low version, 6-poles
70.353.0635.1	Hood BAS GOT GG 6 M25 A1	Hood revos basic made of aluminum, for single locking lever with threaded hole M25 on the right side, low version, 6-poles
70.353.0635.2	Hood BAS GOT GG 6 M25 A2	Hood revos basic made of aluminum, for single locking lever with nozzleM25 on the right side, low version, 6-poles
70.353.0635.3	Hood BAS GOT GG 6 M25 A3	Hood revos basic made of aluminum, for single locking lever with trumpet gland M25 on the right side (IP54), low version, 6-poles
70.354.0635.0	Hood BAS GOT GI 6 M25 A0	Hood revos basic made of aluminum, for single locking lever with cable gland M25 on the top (IP54), low version, 6-poles
70.354.0635.1	Hood BAS GOT GI 6 M25 A1	Hood revos basic made of aluminum, for single locking lever with threaded hole M25 on the top, low version, 6-poles
70.354.0635.2	Hood BAS GOT GI 6 M25 A2	Hood revos basic made of aluminum, for single locking lever with nozzleM25 on the top, low version, 6-poles
70.354.0635.3	Hood BAS GOT GI 6 M25 A3	Hood revos basic made of aluminum, for single locking lever with trumpet gland M25 on the top (IP54), low version, 6-poles
70.372.0635.0	Hood BAS GOT GL 6 M20 50 A0	Hood revos basic made of aluminum, with single locking lever and cable gland M20 on the top - free cable connection (IP54), low version, 6-poles
70.372.0635.1	Hood BAS GOT GL 6 M20 50 A1	Hood revos basic made of aluminum, with single locking lever and threaded hole M20 on the top - free cable connection, low version, 6-poles
70.372.0635.3	Hood BAS GOT GL 6 M20 A3	Hood revos basic made of aluminum, with single locking lever and trumpet gland M20 on the top - free cable connection (IP54), low version, 6-poles
70.450.0637.1	Hood BAS GOM GG 6 M20 B1	Hood revos basic metal-series without coating, for single locking lever with threaded hole M20 on the right side, low version, 6-poles
70.452.0637.1	Hood BAS GOM GI 6 M20 B1	Hood revos basic metal-series without coating, for single locking lever with threaded hole M20 on the top, low version, 6-poles
73.350.0635.0	Hood BAS GOT GG 6HM25 69 A0	Hood revos basic made of aluminum, for single locking lever with cable gland M25 on the right side (IP54), high version, 6-poles
73.350.0635.1	Hood BAS GOT GG 6HM25 69 A1	Hood revos basic made of aluminum, for single locking lever with threaded hole M25 on the right side, high version, 6-poles
73.351.0635.0	Hood BAS GOT GH 6HM20 A0	Hood revos basic made of aluminum, for single locking lever with cable gland M20 on the front (IP54), high version, 6-poles
73.351.0635.1	Hood BAS GOT GH 6HM20 A1	Hood revos basic made of aluminum, for single locking lever with threaded hole M20 on the front, high version, 6-poles
73.351.0635.3	Hood BAS GOT GH 6HM20 A3	Hood revos basic made of aluminum, for single locking lever with trumpet gland M20 on the front (IP54), high version, 6-poles
73.352.0635.0	Hood BAS GOT GI 6HM25 69 A0	Hood revos basic made of aluminum, for single locking lever with cable gland M25 on the top (IP54), high version, 6-poles

73.352.0635.1	Hood BAS GOT GI 6HM25 69 A1	Hood revos basic made of aluminum, for single locking lever with threaded hole M25 on the top, high version, 6-poles
73.352.0635.2	Hood BAS GOT GI 6HM25 69 A2	Hood revos basic made of aluminum, for single locking lever with nozzleM25 on the top, high version, 6-poles
73.352.0635.3	Hood BAS GOT GI 6HM25 A3	Hood revos basic made of aluminum, for single locking lever with trumpet gland M25 on the top (IP54), high version, 6-poles
73.353.0635.0	Hood BAS GOT GG 6HM32 69 A0	Hood revos basic made of aluminum, for single locking lever with cable gland M32 on the right side (IP54), high version, 6-poles
73.353.0635.1	Hood BAS GOT GG 6HM32 69 A1	Hood revos basic made of aluminum, for single locking lever with threaded hole M32 on the right side, high version, 6-poles
73.353.0635.2	Hood BAS GOT GG 6HM32 69 A2	Hood revos basic made of aluminum, for single locking lever with nozzleM32 on the right side, high version, 6-poles
73.353.0635.3	Hood BAS GOT GG 6HM32 A3	Hood revos basic made of aluminum, for single locking lever with trumpet gland M32 on the right side (IP54), high version, 6-poles
73.354.0635.0	Hood BAS GOT GI 6HM32 69 A0	Hood revos basic made of aluminum, for single locking lever with cable gland M32 on the top (IP54), high version, 6-poles
73.354.0635.1	Hood BAS GOT GI 6HM32 69 A1	Hood revos basic made of aluminum, for single locking lever with threaded hole M32 on the top, high version, 6-poles
73.354.0635.2	Hood BAS GOT GI 6HM32 69 A2	Hood revos basic made of aluminum, for single locking lever with nozzleM32 on the top, high version, 6-poles
73.354.0635.3	Hood BAS GOT GI 6HM32 A3	Hood revos basic made of aluminum, for single locking lever with trumpet gland M32 on the top (IP54), high version, 6-poles
70.320.0628.0	Bottom BAS GUT GK 6 A	Bottom-base revos basic made of aluminum, with single locking lever, open, low version, 6-poles
70.325.0628.0	Bottom BAS GUT GP 6 A	Bottom-base revos basic made of aluminum, with single locking lever andprotective cover, open, low version, 6-poles
70.330.0635.0	Bottom BAS GUT GL 6 M20 A0	Bottom-base revos basic made of aluminum, with single locking lever andcable gland M20 on the right and left side (IP54), low version, 6-polig
70.330.0635.1	Bottom BAS GUT GL 6 M20 A1	Bottom-base revos basic made of aluminum, with single locking lever andthreaded hole M20 on the right and left side, low version, 6-polig
70.331.0635.0	Bottom BAS GUT GM 6 M20 A0	Bottom-base revos basic made of aluminum, with single locking lever andcable gland M20 on the left side (IP54), low version, 6-polig
70.331.0635.1	Bottom BAS GUT GM 6 M20 A1	Bottom-base revos basic made of aluminum, with single locking lever andthreaded hole M20 on the left side, low version, 6-polig
70.332.0635.0	Bottom BAS GUT GN 6 M20 A0	Bottom-base revos basic made of aluminum, with single locking lever andcable gland M20 on the right side (IP54), low version, 6-polig
70.332.0635.1	Bottom BAS GUT GN 6 M20 A1	Bottom-base revos basic made of aluminum, with single locking lever andthreaded hole M20 on the right side, low version, 6-polig
70.333.0635.0	Bottom BAS GUT GO 6 M20 A0	Bottom-base revos basic made of aluminum, with single locking lever andcable gland M20 on the bottom (IP54), low version, 6-polig
70.333.0635.1	Bottom BAS GUT GO 6 M20 A1	Bottom-base revos basic made of aluminum, with single locking lever andthreaded hole M20 on the bottom, low version, 6-polig
70.334.0635.0	Bottom BAS GUT GL 6 M25 A0	Bottom-base revos basic made of aluminum, with single locking lever andcable gland M25 on the right and left side (IP54), low version, 6-polig
70.334.0635.1	Bottom BAS GUT GL 6 M25 A1	Bottom-base revos basic made of aluminum, with single locking lever andthreaded hole M25 on the right and left side, low version, 6-polig
70.335.0635.0	Bottom BAS GUT GM 6 M25 50 A0	Bottom-base revos basic made of aluminum, with single locking lever andcable gland M25 on the left side (IP54), low version, 6-polig
70.335.0635.1	Bottom BAS GUT GM 6 M25 A1	Bottom-base revos basic made of aluminum, with single locking lever andthreaded hole M25 on the left side, low version, 6-polig
70.337.0635.1	Bottom BAS GUT GO 6 M25 A1	Bottom-base revos basic made of aluminum, with single locking lever andthreaded hole M25 on the bottom, low version, 6-poles

70.340.0635.0	Bottom BAS GUT GR 6 M20 A0	Bottom-base revos basic made of aluminum, with single locking lever andcable gland M20 on the right and the left side, with protective cover (IP54), low version, 6-polig
70.340.0635.1	Bottom BAS GUT GR 6 M20 A1	Bottom-base revos basic made of aluminum, with single locking lever andthreaded hole M20 on the right and the left side, with protective cover, low version, 6-polig
70.341.0635.0	Bottom BAS GUT GS 6 M20 A0	Bottom-base revos basic made of aluminum, with single locking lever andcable gland M20 on the left side, with protective cover (IP54), low version, 6-polig
70.341.0635.1	Bottom BAS GUT GS 6 M20 A1	Bottom-base revos basic made of aluminum, with single locking lever andthreaded hole M20 on the left side, with protective cover, low version,6-polig
70.342.0635.0	Bottom BAS GUT GT 6 M20 A0	Bottom-base revos basic made of aluminum, with single locking lever andcable gland M20 on the right side, with protective cover (IP54), low version, 6-polig
70.342.0635.1	Bottom BAS GUT GT 6 M20 A1	Bottom-base revos basic made of aluminum, with single locking lever andthreaded hole M20 on the right side, with protective cover, low version, 6-polig
70.343.0635.0	Bottom BAS GUT GU 6 M20 A0	Bottom-base revos basic made of aluminum, with single locking lever andcable gland M20 on the bottom, with protective cover (IP54), low version, 6-polig
70.343.0635.1	Bottom BAS GUT GU 6 M20 A1	Bottom-base revos basic made of aluminum, with single locking lever andthreaded hole M20 on the bottom, with protective cover, low version, 6-polig
70.420.0637.0	Bottom BAS GUM GK 6 B	Bottom-base revos basic metal-series without coating, open, low version, 6-poles
70.425.0637.0	Bottom BAS GUM GP 6 B	Bottom-base revos basic metal-series without coating, with single locking lever and protective cover, low version, 6-poles
70.430.0637.1	Bottom BAS GUM GL 6 M20 B1	Bottom-base revos basic metal-series without coating, with single locking lever and threaded hole M20 on the right and left side, low version, 6-polig
70.431.0637.1	Bottom BAS GUM GM 6 M20 B1	Bottom-base revos basic metal-series without coating, with single locking lever and threaded hole M20 on the left side, low version, 6-polig
70.440.0637.1	Bottom BAS GUM GR 6 M20 B1	Bottom-base revos basic metal-series without coating, with single locking lever and threaded hole M20 on the right and the left side, with protective cover, low version, 6-polig
70.441.0637.1	Bottom BAS GUM GS 6 M20 B1	Bottom-base revos basic metal-series without coating, with single locking lever and threaded hole M20 on the left side, with protective cover, low version, 6-polig
73.330.0635.0	Bottom BAS GUT GL 6HM25 69 A0	Bottom-base revos basic made of aluminum, with single locking lever andcable gland M25 on the right and left side (IP54), high version, 6-polig
73.330.0635.1	Bottom BAS GUT GL 6HM25 69 A1	Bottom-base revos basic made of aluminum, with single locking lever andthreaded hole M25 on the right and left side, high version, 6-polig
73.331.0635.0	Bottom BAS GUT GM 6HM25 69 A0	Bottom-base revos basic made of aluminum, with single locking lever andcable gland M25 on the left side (IP54), high version, 6-polig
73.331.0635.1	Bottom BAS GUT GM 6HM25 69 A1	Bottom-base revos basic made of aluminum, with single locking lever andthreaded hole M25 on the left side, high version, 6-polig
73.334.0635.0	Bottom BAS GUT GL 6HM32 69 A0	Bottom-base revos basic made of aluminum, with single locking lever andcable gland M32 on the right and left side (IP54), high version, 6-polig
73.334.0635.1	Bottom BAS GUT GL 6HM32 69 A1	Bottom-base revos basic made of aluminum, with single locking lever andthreaded hole M32 on the right and left side, high version, 6-polig
73.335.0635.1	Bottom BAS GUT GM 6HM32 69 A1	Bottom-base revos basic made of aluminum, with single locking lever andthreaded hole M32 on the left side, high version, 6-polig

73.340.0635.0	Bottom BAS GUT GR 6HM25 69 A0	Bottom-base revos basic made of aluminum, with single locking lever andcable gland M25 on the right and the left side, with protective cover (IP54), high version, 6-polig
73.340.0635.1	Bottom BAS GUT GR 6HM25 69 A1	Bottom-base revos basic made of aluminum, with single locking lever andthreaded hole M25 on the right and the left side, with protective cover, high version, 6-polig
73.341.0635.0	Bottom BAS GUT GS 6HM25 69 A0	Bottom-base revos basic made of aluminum, with single locking lever andcable gland M25 on the left side, with protective cover (IP54), high version, 6-polig
73.341.0635.1	Bottom BAS GUT GS 6HM25 69 A1	Bottom-base revos basic made of aluminum, with single locking lever andthreaded hole M25 on the left side, with protective cover, high version, 6-polig
73.342.0635.0	Bottom BAS GUT GT 6HM25 69 A0	Bottom-base revos basic made of aluminum, with single locking lever andcable gland M25 on the right side, with protective cover (IP54), high version, 6-polig
73.342.0635.1	Bottom BAS GUT GT 6HM25 69 A1	Bottom-base revos basic made of aluminum, with single locking lever andthreaded hole M25 on the right side, with protective cover, high version, 6-polig
73.344.0635.1	Bottom BAS GUT GR 6HM32 69 A1	Bottom-base revos basic made of aluminum, with single locking lever andthreaded hole M32 on the right and the left side, with protective cover, high version, 6-polig
73.345.0635.1	Bottom BAS GUT GS 6HM32 69 A1	Bottom-base revos basic made of aluminum, with single locking lever andthreaded hole M32 on the left side, with protective cover, high version, 6-polig
73.346.0635.1	Bottom BAS GUT GT 6HM32 69 A1	Bottom-base revos basic made of aluminum, with single locking lever andthreaded hole M32 on the right side, with protective cover, high version, 6-polig
72.300.0653.0	Female insert BAS BUS 6 2,5 69	Female insert revos basic, 6-poles, rated current: 16A, rated voltage: 690V, with tin-plated contacts

A Weitergabe sowie Vervielfältigung dieses Dokuments, Verwertung und Mitteilung seines Inhalts sind verboten, soweit nicht ausdrücklich gestattet. The reproduction, distribution and utilization of this document as well as the communication of its contents to others without express authorization is prohibited.

B These dimensions will be especially checked at delivery
 Only inspection dimensions
 With /E marked dimensions are only valid for internal use

D Diese Maße werden bei Abnahme besonders geprüft
 Ausschließlich Prüfmaße
 Mit /E gekennzeichnete Maße sind nur für interne Zwecke gültig

F

gezeichnete Ausführung: 10-polig
 drawn version: 10-pole insert

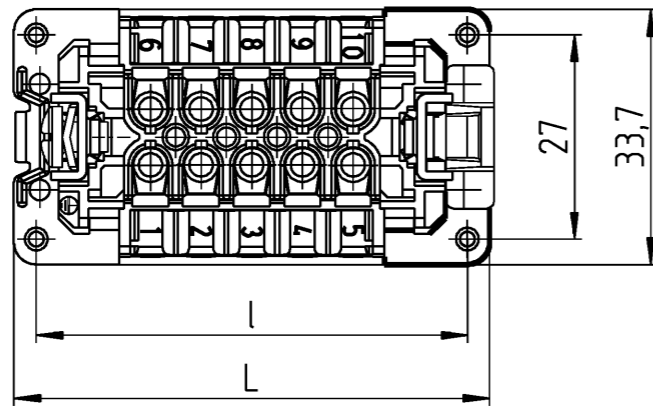
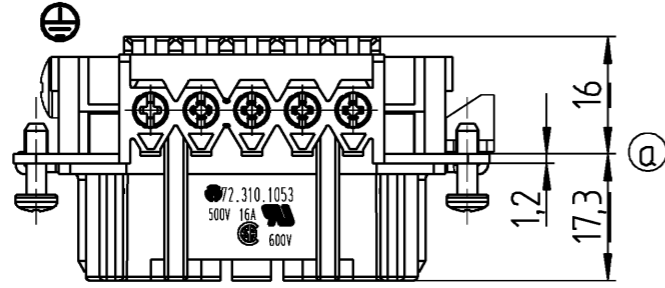

Schutzleiter
 earth conductor

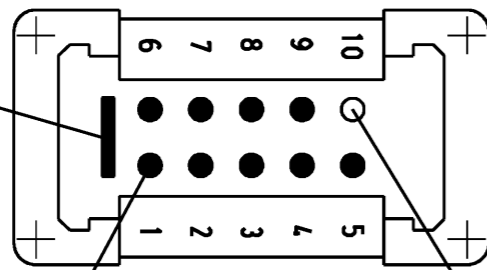

2x Z5.553.3521.0
 Schaltkontakte/switch contact
 6-polig bei Pol 1 u. 6
 10-polig bei Pol 1 u. 10
 16-polig bei Pol 1 u. 16
 24-polig bei Pol 1 u. 24

3

4 Ausführung/
 version:
 6-polig
 6-pole

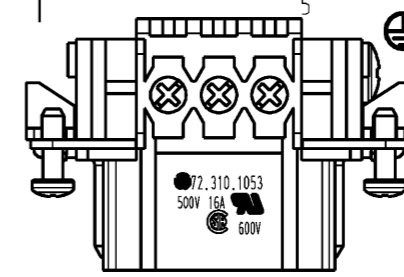

Ausführung/
 version:
 16-polig
 16-pole

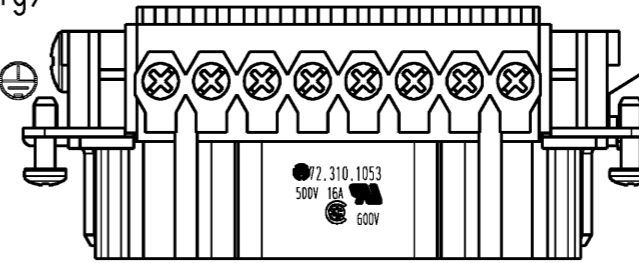

Ausführung/
 version:
 24-polig
 24-pole

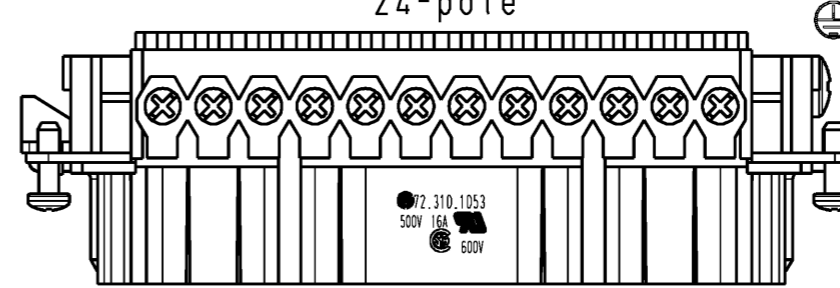

6

Weitere Daten siehe Katalog
 further data see catalog

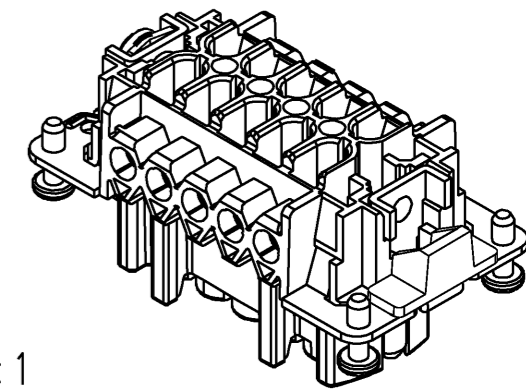

1:1

Teile-Nr. part no.	Maß dimension	
	L	I
72.310.0653.0	49,8	44
72.310.1053.0	62,8	57
72.310.1653.0	83,3	77,5
72.310.2453.0	109,8	104

Tolerierung Size ISO 14405 (E) / Tolerance system Size ISO 14405 (E).
 (This ISO-standard describes the envelope principle. According to the envelope principle the deviations of form and parallelism are limited by the size tolerances).
 ja/yes Stoffverbots- und Deklarationsliste nach WN 5020.010 ist einzuhalten.
 Conformity with Wieland document WN 5020.010 e (list of prohibited / declarable hazardous substances) to be declared!

Freitoleranz nach General tolerance CAD - Zeichnung, keine manuellen Änderungen CAD - drawing, no manual modifications allowed 1. Verwendung: First Use: Blatt: 1 von 1 Sheet: 1 of 1

		Werkstoff / Material		Tag/Date	Name	Zeichnung Nr. / Drawing No.		Index
		Maßstab / Scale		gezeichnet drawn	03.05.2012	Schmitt J.	T 72.310.0653.0 01K	a
		1:1		geprüft checked	Maße in mm / Dimensions are in mm			
		Vol. mm ³ / fl./Srf. mm ²		Ersatz für / Replacement for:				
a 23.08.2017 /		www.wieland		Type		Benennung/Title		
Index Datum / Blatt Date / Sheet		www.wieland-electric.com				Steckereinsatz		
Änderung / Revision						6,10,16 u. 24 pol. STS 2,5 690V 16A male insert 6, 10, 16, 24 pole version		

Weitergabe sowie Vervielfältigung dieses Dokuments, Verwertung und Mitteilung seines Inhalts sind verboten, soweit nicht ausdrücklich gestattet. The reproduction, distribution and utilization of this document as well as the communication of its contents to others without express authorization is prohibited.