



22-V Supply, 10+1 Channel Gamma Correction Buffer

FEATURES

- **Wide Supply Range:** 7 V to 22 V
- **Gamma Correction Channels:** 10
- **Integrated V_{COM} Buffer**
- **Excellent Output Current Drive:**
 - **Gamma Channels:**
> 30 mA at 0.5 V Swing to Rails(1)
 - **V_{COM} :**
> 100 mA typ at 2 V Swing to Rails(1)
- **Large Capacitive Load Drive Capability**
- **Rail-to-Rail Output**
- **PowerPAD™ Package**
- **Low-Power/Channel:** < 500 μ A
- **High ESD Rating:** 8 kV HBM, 2 kV CDM, 300 V MM
- **Specified for -25°C to $+85^{\circ}\text{C}$**

(1) See Typical Characteristic curves for details.

DESCRIPTION

The BUF11705 is a multi-channel buffer targeted towards gamma correction in high-resolution LCD panels. It is pin-compatible with the existing BUF11702 and BUF11704 and operates at higher supply voltages up to 22 V (24 V absolute max). The higher supply voltage enables faster response times and brighter images in large-screen LCD panels. This is especially important in LCD TV applications.

The BUF11705 offers 10 gamma channels. For additional space and cost savings, a V_{COM} channel with > 100 mA drive capability is integrated into the BUF11705.

The BUF11705 is available in the TSSOP-28 PowerPAD package for dramatically increased power dissipation capability. This allows a large number of channels to be handled safely in one package.

A flow-through pinout has been adopted to allow simple PCB routing and maintain cost-effectiveness. All inputs and outputs of the BUF11705 incorporate internal ESD protection circuits that prevent functional failures at voltages up to 8 kV (HBM), 2 kV (CDM), and 300 V (MM).

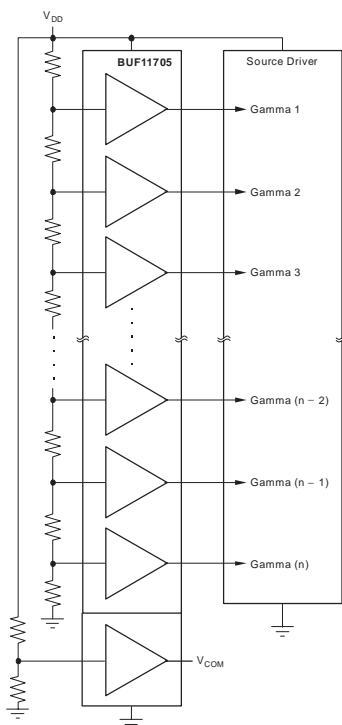

Please be aware that an important notice concerning availability, standard warranty, and use in critical applications of Texas Instruments semiconductor products and disclaimers thereto appears at the end of this data sheet.

PowerPAD is a trademark of Texas Instruments. All other trademarks are the property of their respective owners.



This integrated circuit can be damaged by ESD. Texas Instruments recommends that all integrated circuits be handled with appropriate precautions. Failure to observe proper handling and installation procedures can cause damage.

ESD damage can range from subtle performance degradation to complete device failure. Precision integrated circuits may be more susceptible to damage because very small parametric changes could cause the device not to meet its published specifications.

ABSOLUTE MAXIMUM RATINGS⁽¹⁾

Over operating free-air temperature range unless otherwise noted.

PARAMETERS	BUF11705	UNIT
Supply voltage, V_{DD} ⁽²⁾	24	V
Input voltage range, V_I	$\pm V_{DD}$	
Continuous total power dissipation	See dissipation rating table	
Operating free-air temperature range, T_A	-25 to +85	°C
Maximum junction temperature, T_J	+125	°C
Storage temperature range, T_{STG}	-65 to +150	°C
Lead temperature 1.6mm (1/16 inch) from case for 10s	+260	°C
ESD rating:		
Human body model (HBM)	8	kV
Charged-device model (CDM)	2	kV
Machine model (MM)	300	V

(1) Stresses beyond those listed under absolute maximum ratings may cause permanent damage to the device. These are stress ratings only, and functional operation of the device at these or any other conditions beyond those indicated under recommended operating conditions is not implied. Exposure to absolute-maximum-rated conditions for extended periods may affect device reliability.

(2) All voltage values are with respect to GND.

ORDERING INFORMATION⁽¹⁾

PRODUCT	PACKAGE-LEAD	PACKAGE MARKING
BUF11705	TSSOP-28	BUF11705

(1) For the most current package and ordering information, see the Package Option Addendum located at the end of this data sheet or see the TI website at www.ti.com.

DISSIPATION RATING TABLE

PACKAGE TYPE	PACKAGE DESIGNATOR	θ_{JC} ⁽¹⁾ (°C/W)	θ_{JA} ⁽¹⁾ (°C/W)	$T_A \leq 25^\circ\text{C}$ POWER RATING
TSSOP-28	PWP (28)	0.72	27.9	3.58 W

(1) PowerPAD attached to PCB, 0 lfm airflow, and 76mm x 76mm copper area.

RECOMMENDED OPERATING CONDITIONS

	MIN	NOM	MAX	UNIT
Supply voltage, V_{DD}	7		22	V
Operating free-air temperature, T_A	-25		+85	°C

ELECTRICAL CHARACTERISTICS: BUF11705

 Over operating free-air temperature range, $V_{DD} = 18\text{ V}$, $T_A = +25^\circ\text{C}$, unless otherwise noted.

PARAMETER			TEST CONDITIONS	T_A	MIN	TYP	MAX	UNIT
V_{IO}	Input offset voltage	Gamma buffers	$V_I = 9\text{ V}$	+25°C	-1		20	mV
		V_{COM}		Full range(1)			20	
				+25°C	-1		30	
		Full range(1)				30		
I_{IB}	Input bias current		$V_I = V_{DD}/2$	+25°C		1		pA
				Full range(1)		200		
PSRR	Power-Supply Rejection Ratio		$V_{DD} = 4.5\text{ V to }22\text{ V}$	+25°C	62	80		dB
				Full range(1)	60			
Buffer gain				+25°C		0.9995		V/V
BW_3dB	3dB bandwidth	Gamma buffers V_{COM} buffer	$C_L = 100\text{ pF}$, $R_L = 2\text{ k}\Omega$	+25°C		1 0.6		MHz
SR	Slew rate	Gamma buffers V_{COM} buffer	$C_L = 100\text{ pF}$, $R_L = 2\text{ k}\Omega$ $V_{IN} = 2\text{ V to }16\text{ V}$	+25°C		1.6		V/ μs
						4.6		
	Crosstalk		$V_{Ipp} = 6\text{ V}$, $f = 1\text{ kHz}$	+25°C		85		dB
I_{DD}	Supply current	ALL	$V_O = V_{DD}/2$ No Load	25°C		5	9.0	mA
				Full range			9.0	
Common-mode input range		Buffers 1-5		+25°C		1	V_{DD}	V
		Buffers 6-10			GND	$V_{DD} - 1$		
		V_{COM} buffer			1	V_{DD}		
Load regulation		V_{COM} buffer sinking	$I_O = 1\text{ mA to }100\text{ mA}$, $V_{IN} = 2\text{ V}$	+25°C		1	5	mV/mA
				Full range			5	
		V_{COM} buffer sourcing	$I_O = -1\text{ mA to }-100\text{ mA}$ $V_{IN} = 16\text{ V}$	+25°C		1	5	
				Full range			5	
		Buffers 1-10 sinking	$I_O = 1\text{ mA to }10\text{ mA}$ $V_{IN} = 1\text{ V}$	+25°C		1	5	
				Full range			5	
		Buffers 1-10 sourcing	$I_O = -1\text{ mA to }-10\text{ mA}$ $V_{IN} = 17\text{ V}$	+25°C		1	5	
				Full range			5	
V_{OH1-5}	High-level output voltage	Buffers 1-5	$V_{IN} = 18\text{ V}$ $I_{SOURCE} = 10\text{ mA}$	+25°C	17.85	17.9		V
V_{OH6-10}		Buffers 6-10	$V_{IN} = 17\text{ V}$ $I_{SINK} = 10\text{ mA}$	+25°C		17	17.15	V
	$V_{IN} = 17\text{ V}$ $I_{SOURCE} = 10\text{ mA}$		16.85		17			
V_{OL1-5}	Low-level output voltage	Buffers 1-5	$V_{IN} = 1\text{ V}$ $I_{SINK} = 10\text{ mA}$	+25°C		1.0	1.15	V
			$V_{IN} = 1\text{ V}$ $I_{SOURCE} = 10\text{ mA}$		0.85	1.0		
V_{OL6-10}		Buffers 6-10	$V_{IN} = 0\text{ V}$ $I_{SINK} = 10\text{ mA}$	+25°C		0	0.15	V
V_{OHCOM}	High-level output voltage	V_{COM} buffer	$V_{IN} = 16\text{ V}$ $I_{SINK} = 100\text{ mA}$	+25°C		16	16.15	V
			$V_{IN} = 16\text{ V}$ $I_{SOURCE} = 100\text{ mA}$		15.85	16		
V_{OLCOM}	Low-level output voltage	V_{COM} buffer	$V_{IN} = 2\text{ V}$ $I_{SINK} = 100\text{ mA}$	+25°C		2	2.15	V
			$V_{IN} = 2\text{ V}$ $I_{SOURCE} = 100\text{ mA}$		1.85	2		

 (1) Full range is -25°C to $+85^\circ\text{C}$.

EQUIVALENT SCHEMATICS OF INPUTS AND OUTPUTS

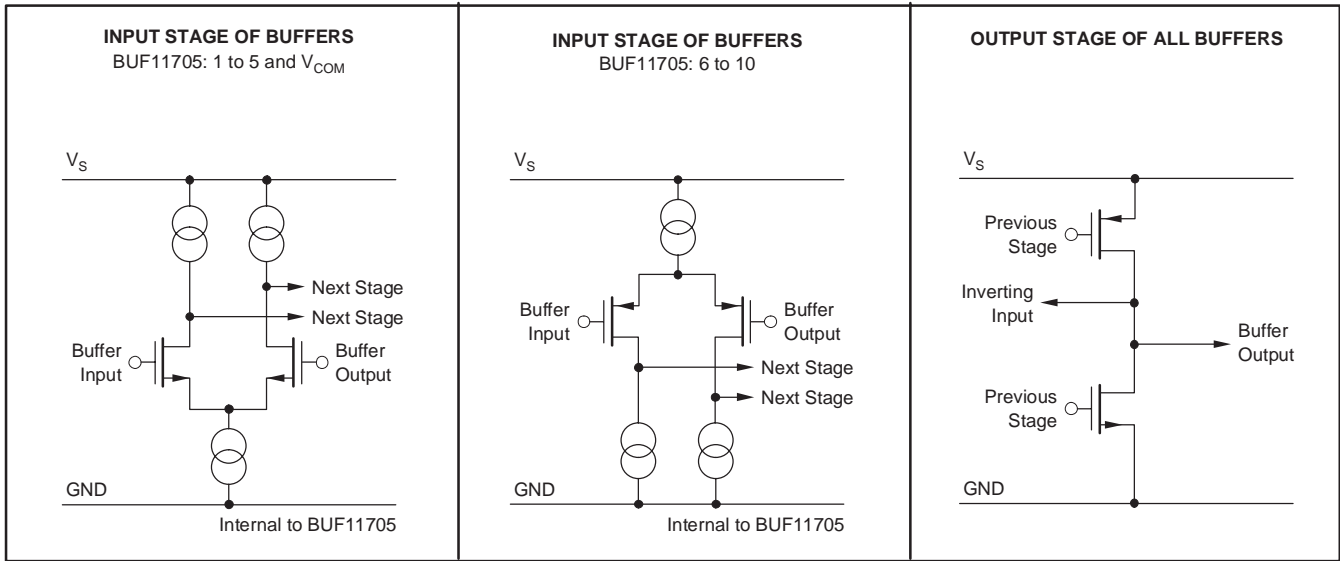

PIN CONFIGURATION

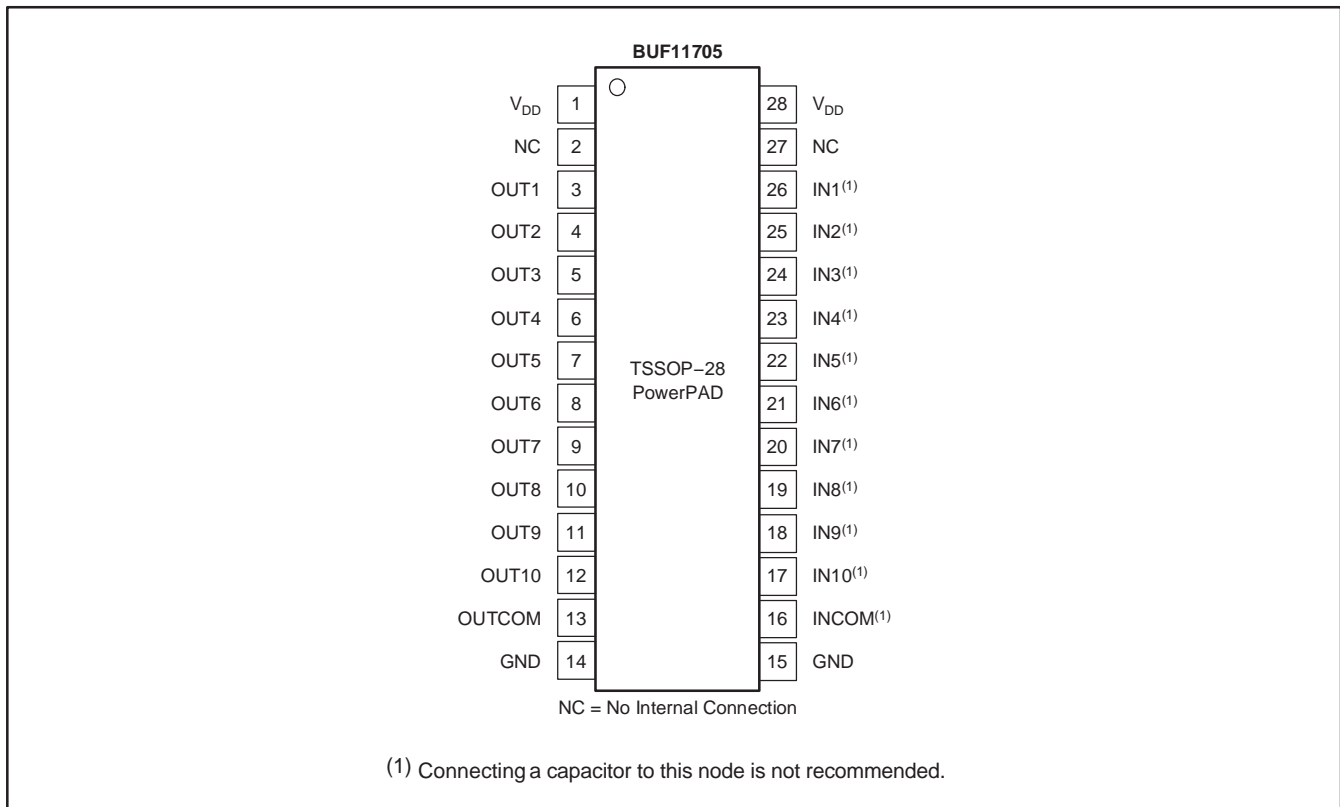

TYPICAL CHARACTERISTICS

Over operating free-air temperature range, unless otherwise noted.

DC CURVES

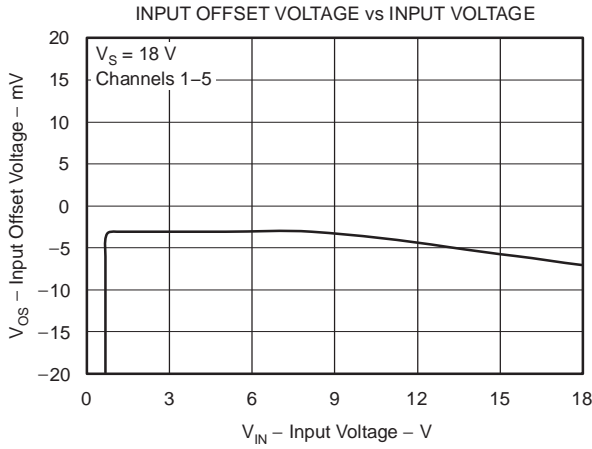

Figure 1

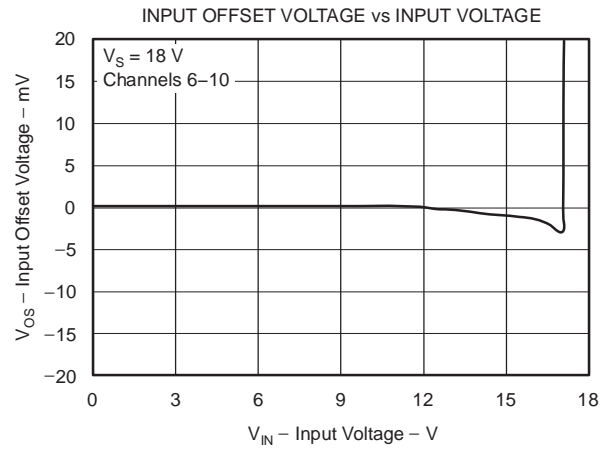

Figure 2

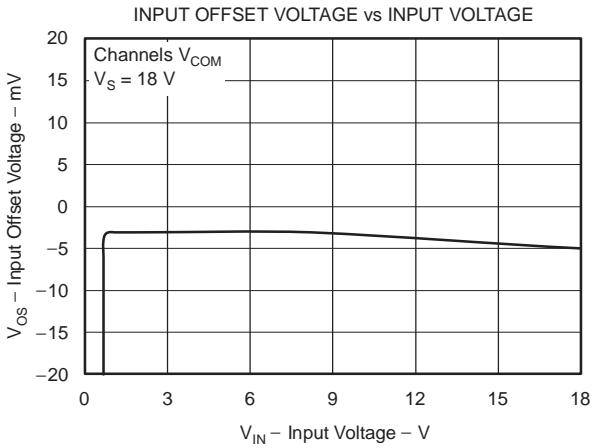

Figure 3

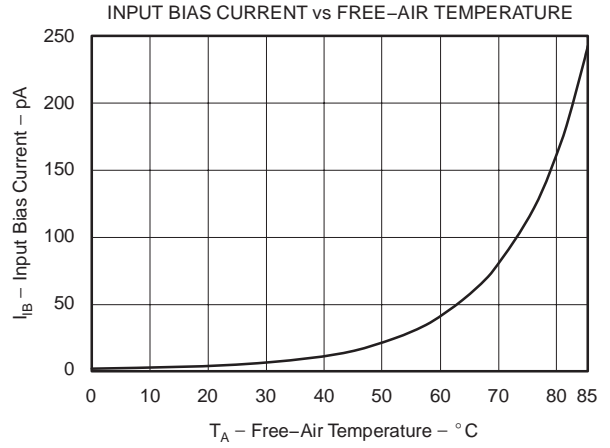

Figure 4

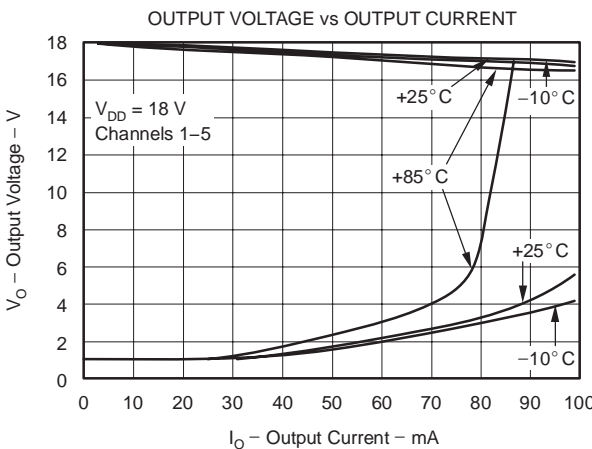

Figure 5

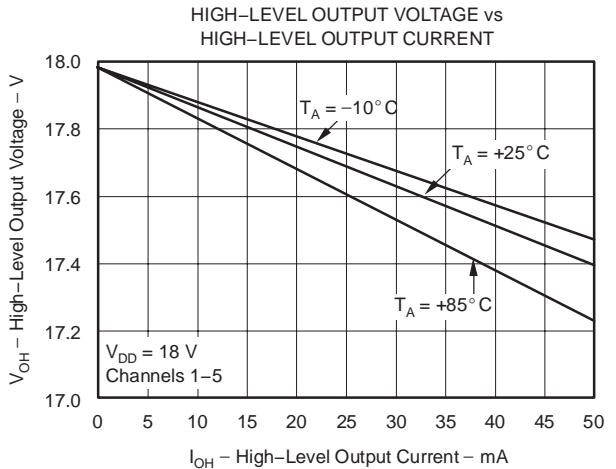

Figure 6

TYPICAL CHARACTERISTICS (continued)

Over operating free-air temperature range, unless otherwise noted.

DC CURVES (continued)

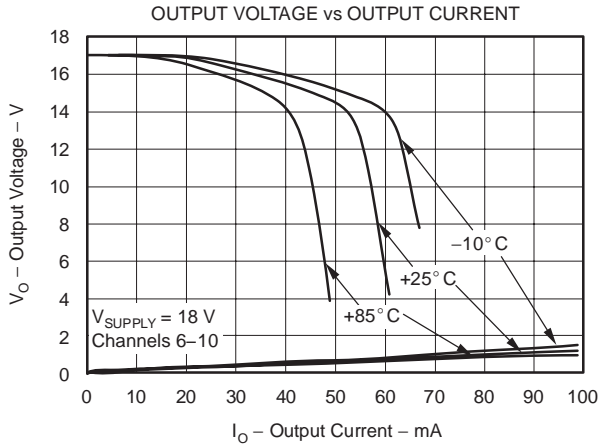

Figure 7

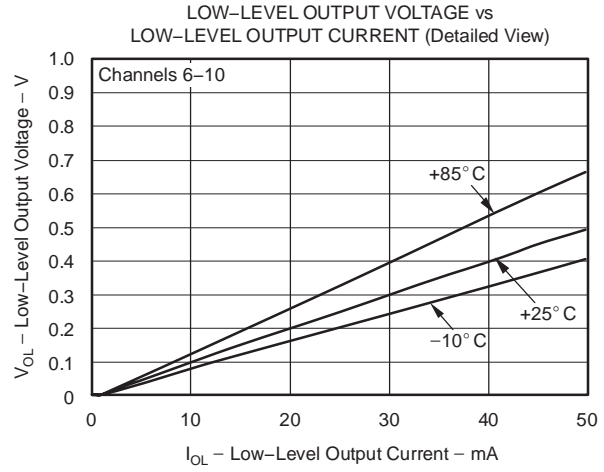

Figure 8

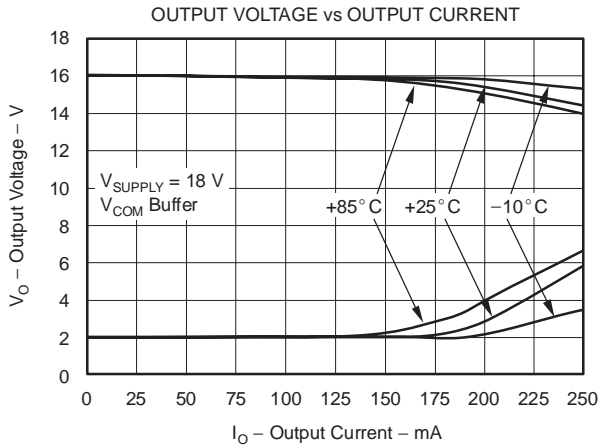

Figure 9

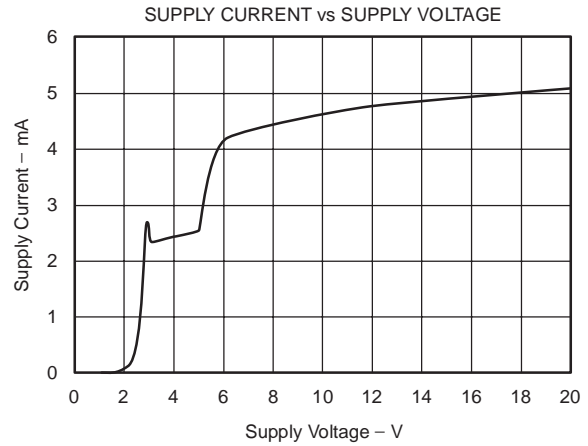

Figure 10

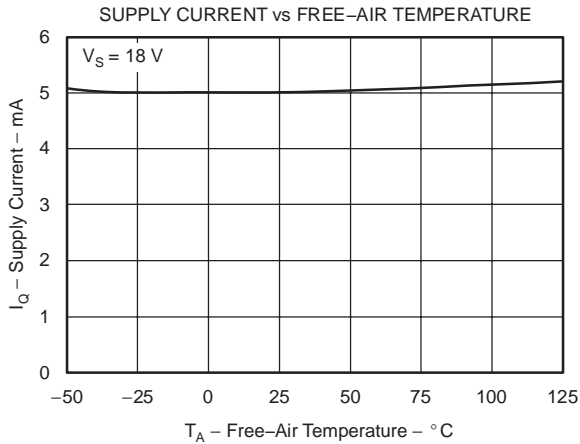

Figure 11

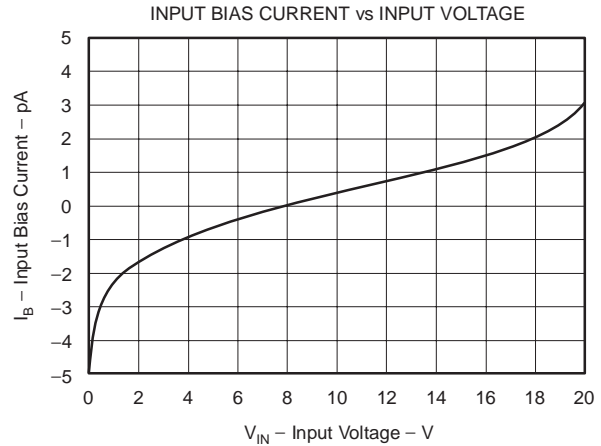

Figure 12

TYPICAL CHARACTERISTICS (continued)

Over operating free-air temperature range, unless otherwise noted.

AC CURVES

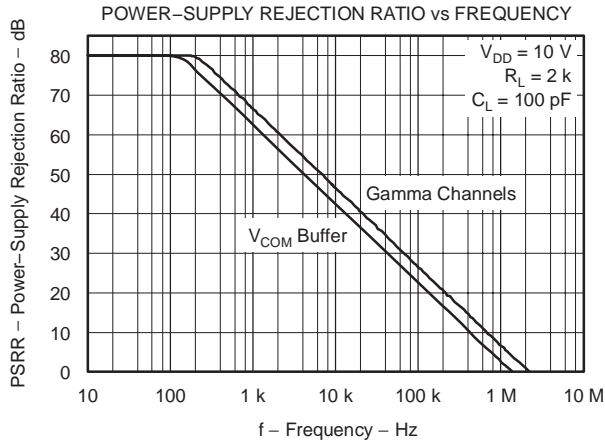

Figure 13

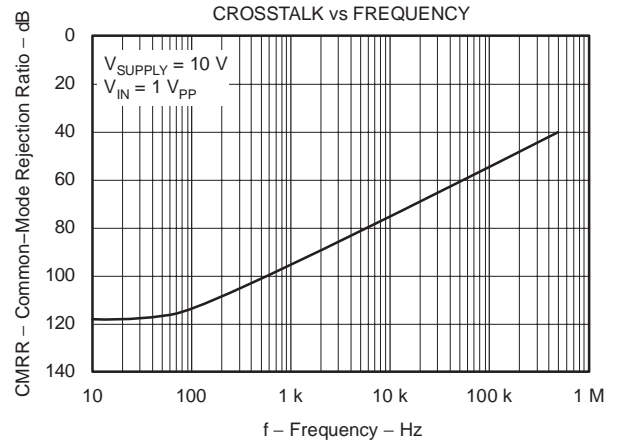

Figure 14

TYPICAL CHARACTERISTICS (continued)

Over operating free-air temperature range, unless otherwise noted.

SMALL- AND LARGE-SIGNAL WAVEFORM CURVES

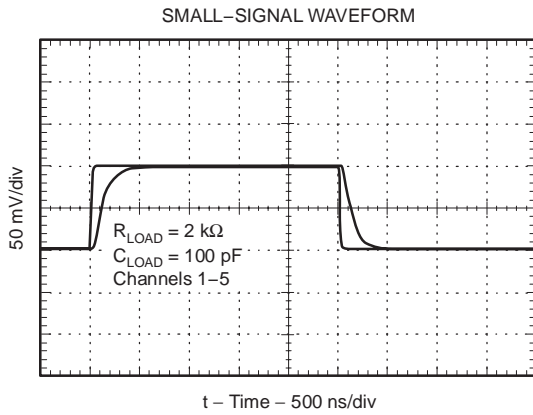

Figure 15

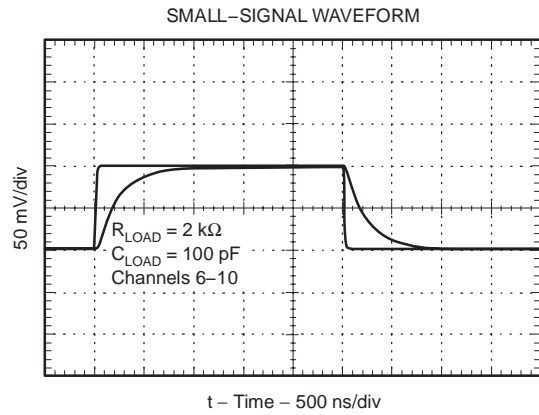

Figure 16

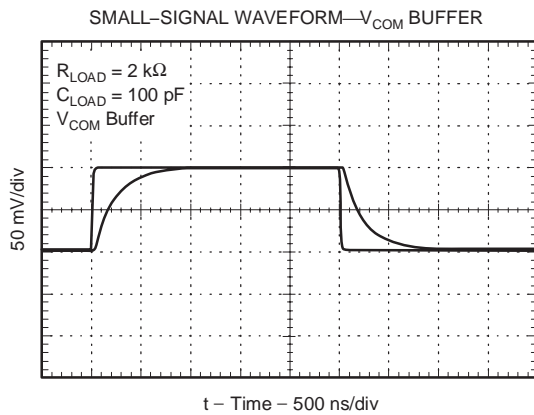

Figure 17

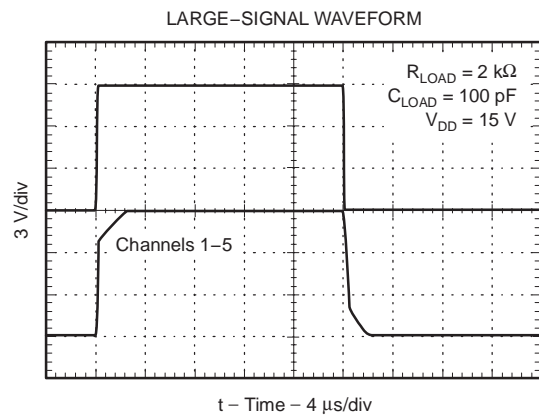

Figure 18

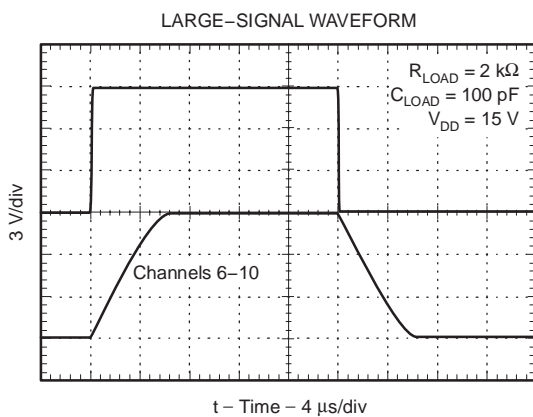

Figure 19

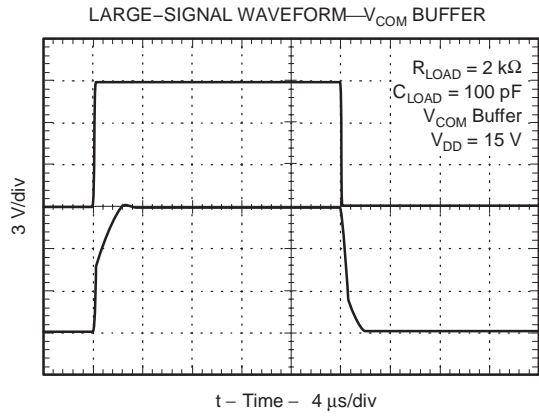

Figure 20

APPLICATION INFORMATION

The requirements on the number of gamma correction channels vary greatly from panel to panel. Therefore, the BUF11705 series of gamma correction buffers offer different channel combinations using 10 gamma channels plus one V_{COM} channel. The V_{COM} channel can be used to drive the V_{COM} node on the LCD panel.

Gamma correction voltages are often generated using a simple resistor ladder, as shown in Figure 21. The BUF11705 buffers the various nodes on the gamma

correction resistor ladder. The low output impedance of the BUF11705 forces the external gamma correction voltage on the respective reference node of the LCD source driver. Figure 21 shows an example of the BUF11705 in a typical block diagram driving an LCD source driver with 10-channel gamma correction reference inputs.

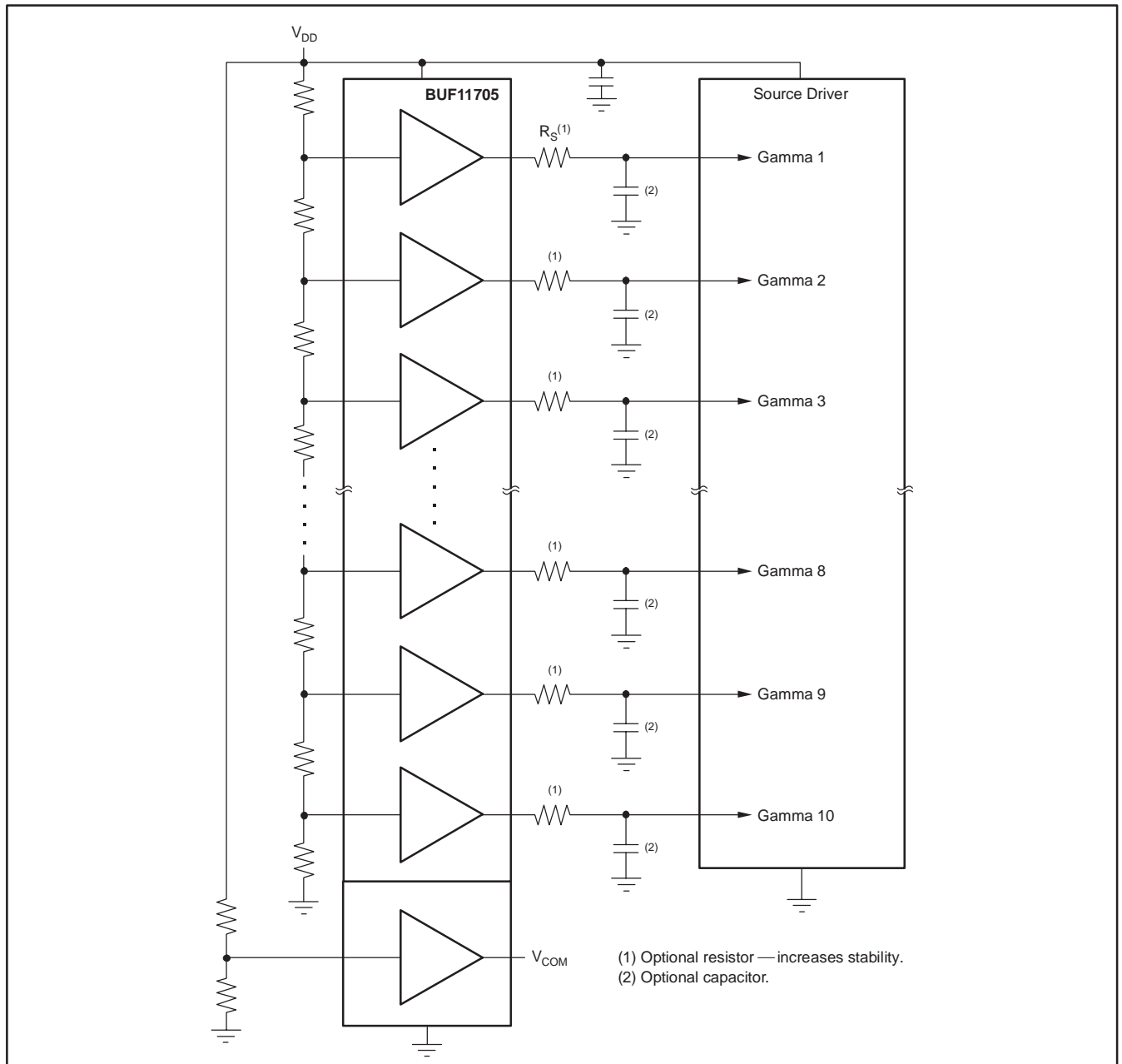

Figure 21. LCD Source Driver Typical Block Diagram

ESD RATINGS

The BUF11705 has excellent ESD performance: 8 kV HBM; 2 kV CDM; and 300 V MM. These ESD ratings allow for increased manufacturability, fewer production failures, and higher reliability.

INPUT VOLTAGE RANGE GAMMA BUFFERS

Figure 22 shows a typical gamma correction curve with 10 gamma correction reference points (GMA1 through GMA10). As can be seen from this curve, the voltage requirements for each buffer vary greatly. The swing capability of the input stages of the various buffers is carefully matched to the application. Buffers 1 through 5 have input stages that include V_{DD} , but will only swing within 1 V to GND. Buffers 1 through 5 have only a single NMOS input stage. Buffers 6 through 10 have only a single PMOS input stage. The input range of the PMOS input stage includes GND.

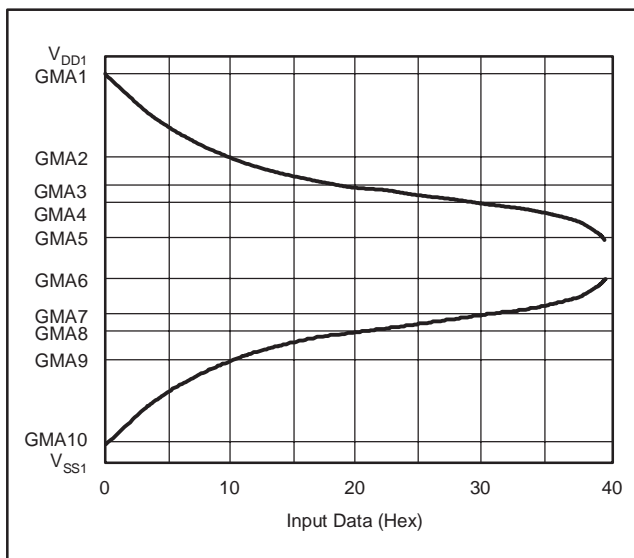

Figure 22. Gamma Correction Curve

OUTPUT VOLTAGE SWING GAMMA BUFFERS

The output stages have been designed to match the characteristic of the input stage. This means that the output stage of buffers 1 through 5 swing very close to

V_{DD} (typically, $V_{CC} - 100\text{ mV}$ at 10 mA). The ability of buffers 1 through 5 to swing to GND is limited. Buffers 6 through 10 swing closer to GND than V_{DD} . Buffers 6 through 10 are designed to swing very close to GND; typically, $GND + 100\text{ mV}$ at a 10 mA load current. See the *Typical Characteristics* for more details. This approach significantly reduces the silicon area and overall cost of the whole solution. However, due to this architecture, the correct buffer must be connected to the correct gamma correction voltage. Connect buffer 1 to the gamma voltage closest to V_{DD} , and buffers 2 through 5 to the sequentially voltages. Buffer 10 should be connected to the gamma correction voltage closest to GND (or the negative rail), and buffers 9 through 6 to the sequentially higher voltages.

COMMON BUFFER (V_{COM})

The common buffer output of the BUF11705 has a greater output drive capability than the gamma buffers in order to meet the heavier current demands of driving the common node of the LCD panel. The common buffer output was also designed to drive heavier capacitive loads. Excellent output swing is possible with high currents ($> 100\text{ mA}$), as shown in Figure 23.

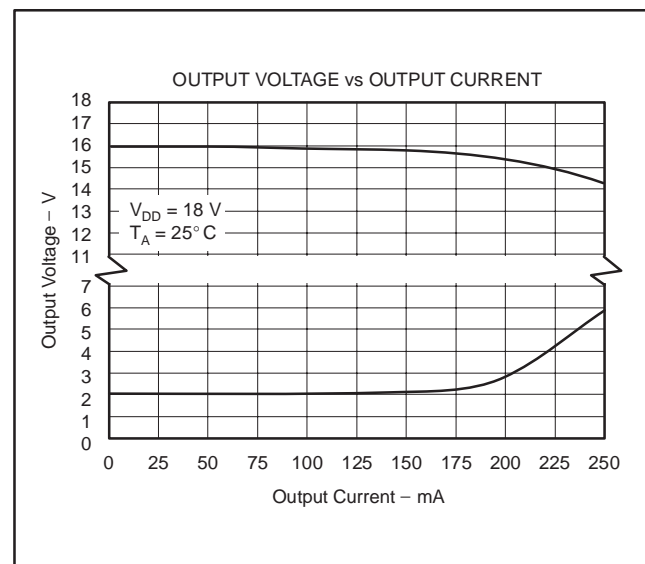

Figure 23. V_{COM} Output Drive Capability

CAPACITIVE LOAD DRIVE

The BUF11705 has been designed to sink/source large dc currents. Its output stage has been designed to deliver output current transients with little disturbance of the output voltage. However, there are times when very fast current pulses are required. Therefore, in LCD source driver buffer applications, it is quite normal for capacitors to be placed at the outputs of the reference buffers. These capacitors improve the transient load regulation and will typically have values of 100pF or more. The BUF11705 gamma buffers were designed to drive capacitances in excess of 100 pF. The output is able to swing within 150 mV of the rails on 10 mA of output current, as shown in Figure 24.

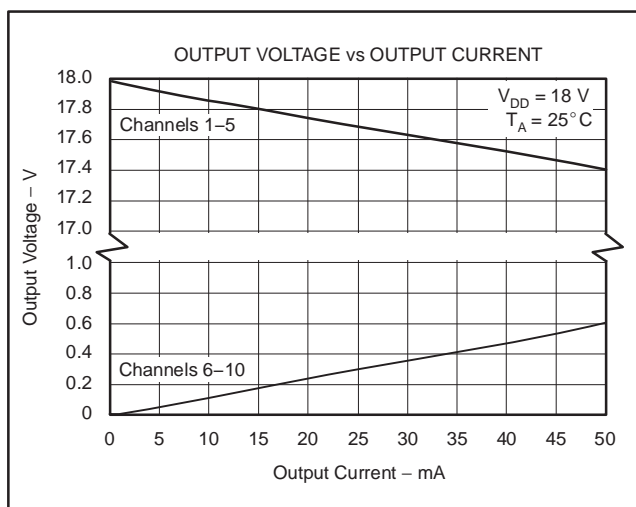

Figure 24. Gamma Buffer Drive Capability

APPLICATIONS WITH >10 GAMMA CHANNELS

When a greater number of gamma correction channels are required, two or more BUF11705 devices can be used in parallel, as shown in Figure 25. This capability provides a cost-effective way of creating more reference voltages over the use of quad-channel op amps or buffers. The suggested configuration in Figure 25 simplifies layout. The various different channel versions provide a high degree of flexibility and also minimize total cost and space.

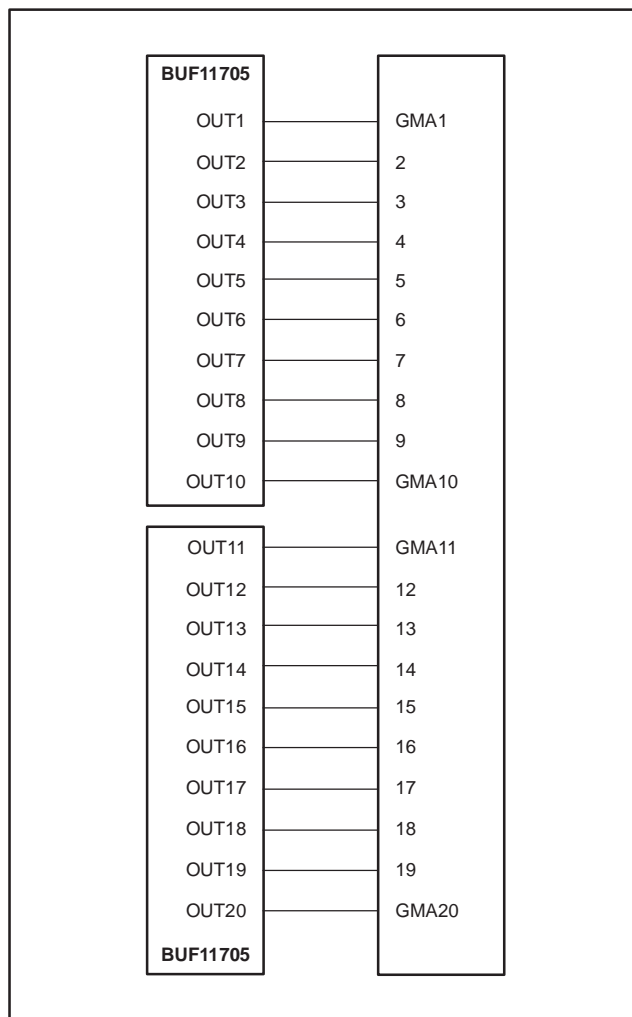

Figure 25. Creating > 10 Gamma Voltage Channels

COMPLETE LCD SOLUTION FROM TI

In addition to the BUF11705 line of gamma correction buffers, TI offers a complete set of ICs for the LCD panel

market, including various power-supply solutions, and audio power solutions. Figure 26 shows the total IC solution from TI.

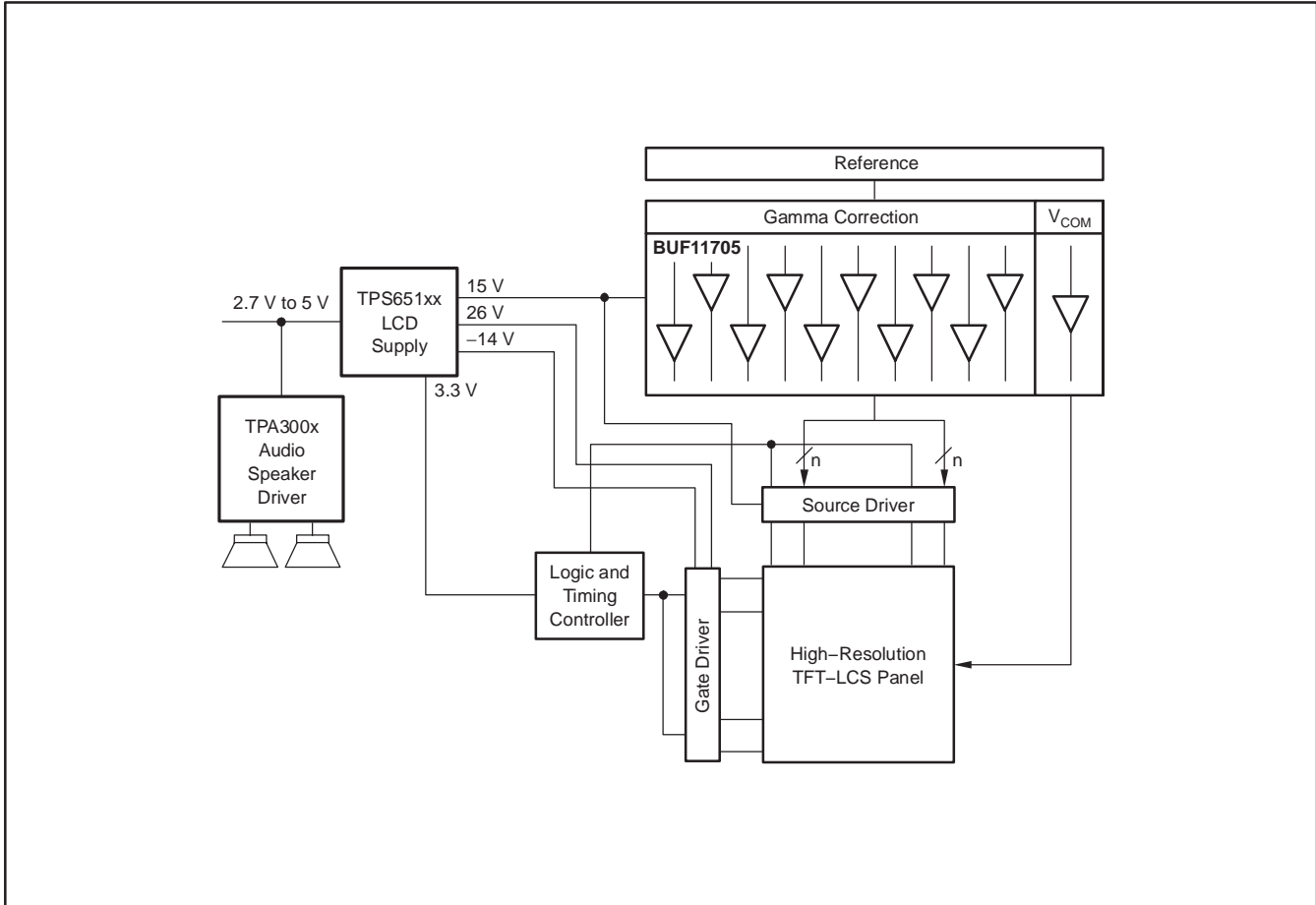

Figure 26. TI LCD Solution

GENERAL PowerPAD DESIGN CONSIDERATIONS

The BUF11705 is available in the thermally-enhanced PowerPAD package. This package is constructed using a downset leadframe upon which the die is mounted, as shown in Figure 27(a) and (b). This arrangement results in the lead frame being exposed as a thermal pad on the underside of the package; see Figure 27(c). Due to this thermal pad having direct thermal contact with the die, excellent thermal performance is achieved by providing a good thermal path away from the thermal pad.

The PowerPAD package allows for both assembly and thermal management in one manufacturing operation. During the surface-mount solder operation (when the leads are being soldered), the thermal pad must be soldered to a copper area underneath the package. Through the use of thermal paths within this copper area, heat can be conducted away from the package into either a ground plane or other heat-dissipating device. **Soldering the PowerPAD to the PCB is always required, even with applications that have low power dissipation.** This provides the necessary thermal and mechanical connection between the lead frame die pad and the PCB.

The PowerPAD must be connected to the most negative supply voltage of the device.

1. Prepare the PCB with a top-side etch pattern. There should be etching for the leads as well as etch for the thermal pad.
2. Place recommended holes in the area of the thermal pad. Ideal thermal land size and thermal via patterns can be seen in technical brief, SLMA002 *PowerPAD Thermally-Enhanced Package*, available for download at www.ti.com. These holes should be 13 mils (0.33 mm) in diameter. Keep them small, so that solder wicking through the holes is not a problem during reflow.

3. Additional vias may be placed anywhere along the thermal plane outside of the thermal pad area. This helps dissipate the heat generated by the BUF11705 IC. These additional vias may be larger than the 13-mil diameter vias directly under the thermal pad. They can be larger because they are not in the thermal pad area to be soldered; so that, wicking is not a problem.
4. Connect all holes to the internal ground plane.
5. When connecting these holes to the ground plane, do not use the typical web or spoke via connection methodology. Web connections have a high thermal resistance connection that is useful for slowing the heat transfer during soldering operations. Web connections make the soldering of vias easier. In this application, however, low thermal resistance is desired for the most efficient heat transfer. Therefore, the holes under the BUF11705 PowerPAD package should make their connection to the internal ground plane with a complete connection around the entire circumference of the plated-through hole.
6. The top-side solder mask should leave the terminals of the package and the thermal pad area with its ten holes exposed. The bottom-side solder mask should cover the holes of the thermal pad area. This prevents solder from being pulled away from the thermal pad area during the reflow process.
7. Apply solder paste to the exposed thermal pad area and all of the IC terminals.
8. With these preparatory steps in place, the BUF11705 IC is simply placed in position and run through the solder reflow operation as any standard surface-mount component. This preparation results in a properly installed part.

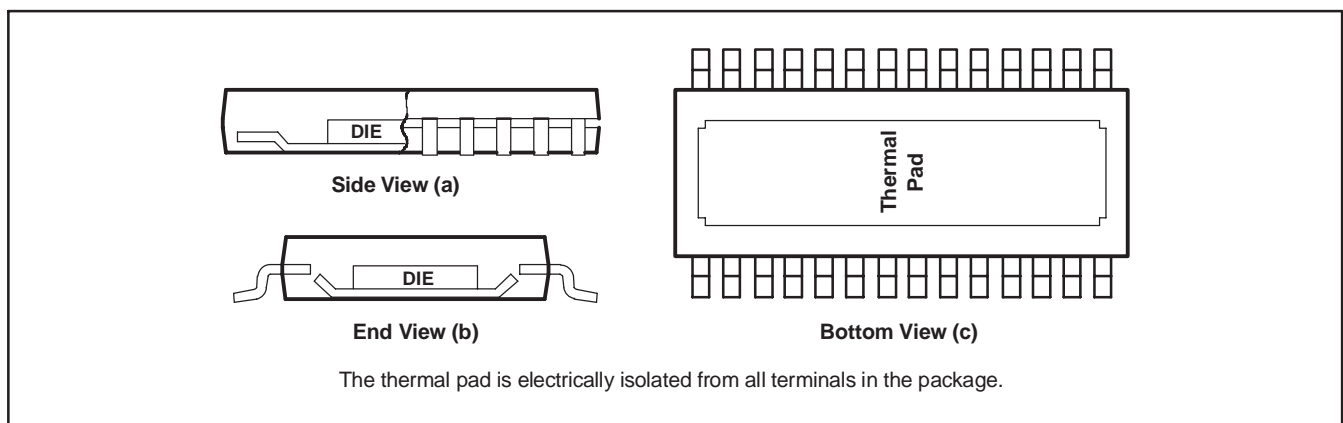

Figure 27. Views of Thermally-Enhanced DGN Package

For a given θ_{JA} , the maximum power dissipation is shown in Figure 28, and is calculated by the following formula:

$$P_D = \left(\frac{T_{MAX} - T_A}{\theta_{JA}} \right)$$

Where:

P_D = maximum power dissipation (W)

T_{MAX} = absolute maximum junction temperature (125°C)

T_A = free-ambient air temperature (°C)

$\theta_{JA} = \theta_{JC} + \theta_{CA}$

θ_{JC} = thermal coefficient from junction to case (°C/W)

θ_{CA} = thermal coefficient from case-to-ambient air (°C/W)

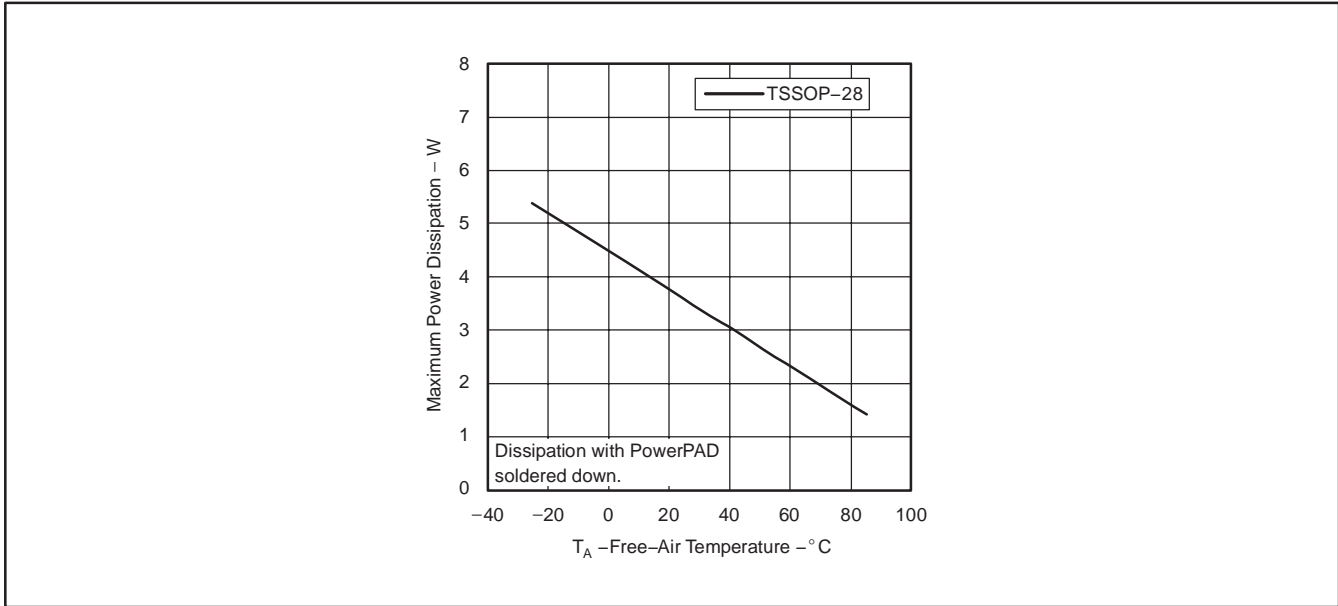

Figure 28. Views of Thermally-Enhanced DGN Package

PACKAGING INFORMATION

Orderable Device	Status (1)	Package Type	Package Drawing	Pins	Package Qty	Eco Plan (2)	Lead/Ball Finish (6)	MSL Peak Temp (3)	Op Temp (°C)	Device Marking (4/5)	Samples
BUF11705AIPWPR	NRND	HTSSOP	PWP	28	2000	Green (RoHS & no Sb/Br)	CU NIPDAU	Level-2-260C-1 YEAR	-25 to 85	BUF11705	

(1) The marketing status values are defined as follows:

ACTIVE: Product device recommended for new designs.

LIFEBUY: TI has announced that the device will be discontinued, and a lifetime-buy period is in effect.

NRND: Not recommended for new designs. Device is in production to support existing customers, but TI does not recommend using this part in a new design.

PREVIEW: Device has been announced but is not in production. Samples may or may not be available.

OBSOLETE: TI has discontinued the production of the device.

(2) Eco Plan - The planned eco-friendly classification: Pb-Free (RoHS), Pb-Free (RoHS Exempt), or Green (RoHS & no Sb/Br) - please check <http://www.ti.com/productcontent> for the latest availability information and additional product content details.

TBD: The Pb-Free/Green conversion plan has not been defined.

Pb-Free (RoHS): TI's terms "Lead-Free" or "Pb-Free" mean semiconductor products that are compatible with the current RoHS requirements for all 6 substances, including the requirement that lead not exceed 0.1% by weight in homogeneous materials. Where designed to be soldered at high temperatures, TI Pb-Free products are suitable for use in specified lead-free processes.

Pb-Free (RoHS Exempt): This component has a RoHS exemption for either 1) lead-based flip-chip solder bumps used between the die and package, or 2) lead-based die adhesive used between the die and leadframe. The component is otherwise considered Pb-Free (RoHS compatible) as defined above.

Green (RoHS & no Sb/Br): TI defines "Green" to mean Pb-Free (RoHS compatible), and free of Bromine (Br) and Antimony (Sb) based flame retardants (Br or Sb do not exceed 0.1% by weight in homogeneous material)

(3) MSL, Peak Temp. - The Moisture Sensitivity Level rating according to the JEDEC industry standard classifications, and peak solder temperature.

(4) There may be additional marking, which relates to the logo, the lot trace code information, or the environmental category on the device.

(5) Multiple Device Markings will be inside parentheses. Only one Device Marking contained in parentheses and separated by a "~" will appear on a device. If a line is indented then it is a continuation of the previous line and the two combined represent the entire Device Marking for that device.

(6) Lead/Ball Finish - Orderable Devices may have multiple material finish options. Finish options are separated by a vertical ruled line. Lead/Ball Finish values may wrap to two lines if the finish value exceeds the maximum column width.

Important Information and Disclaimer: The information provided on this page represents TI's knowledge and belief as of the date that it is provided. TI bases its knowledge and belief on information provided by third parties, and makes no representation or warranty as to the accuracy of such information. Efforts are underway to better integrate information from third parties. TI has taken and continues to take reasonable steps to provide representative and accurate information but may not have conducted destructive testing or chemical analysis on incoming materials and chemicals. TI and TI suppliers consider certain information to be proprietary, and thus CAS numbers and other limited information may not be available for release.

In no event shall TI's liability arising out of such information exceed the total purchase price of the TI part(s) at issue in this document sold by TI to Customer on an annual basis.

TAPE AND REEL INFORMATION



QUADRANT ASSIGNMENTS FOR PIN 1 ORIENTATION IN TAPE



*All dimensions are nominal

Device	Package Type	Package Drawing	Pins	SPQ	Reel Diameter (mm)	Reel Width W1 (mm)	A0 (mm)	B0 (mm)	K0 (mm)	P1 (mm)	W (mm)	Pin1 Quadrant
BUF11705AIPWPR	HTSSOP	PWP	28	2000	330.0	16.4	6.9	10.2	1.8	12.0	16.0	Q1

TAPE AND REEL BOX DIMENSIONS



*All dimensions are nominal

Device	Package Type	Package Drawing	Pins	SPQ	Length (mm)	Width (mm)	Height (mm)
BUF11705AIPWPR	HTSSOP	PWP	28	2000	367.0	367.0	38.0

MECHANICAL DATA

PWP (R-PDSO-G28)

PowerPAD™ PLASTIC SMALL OUTLINE

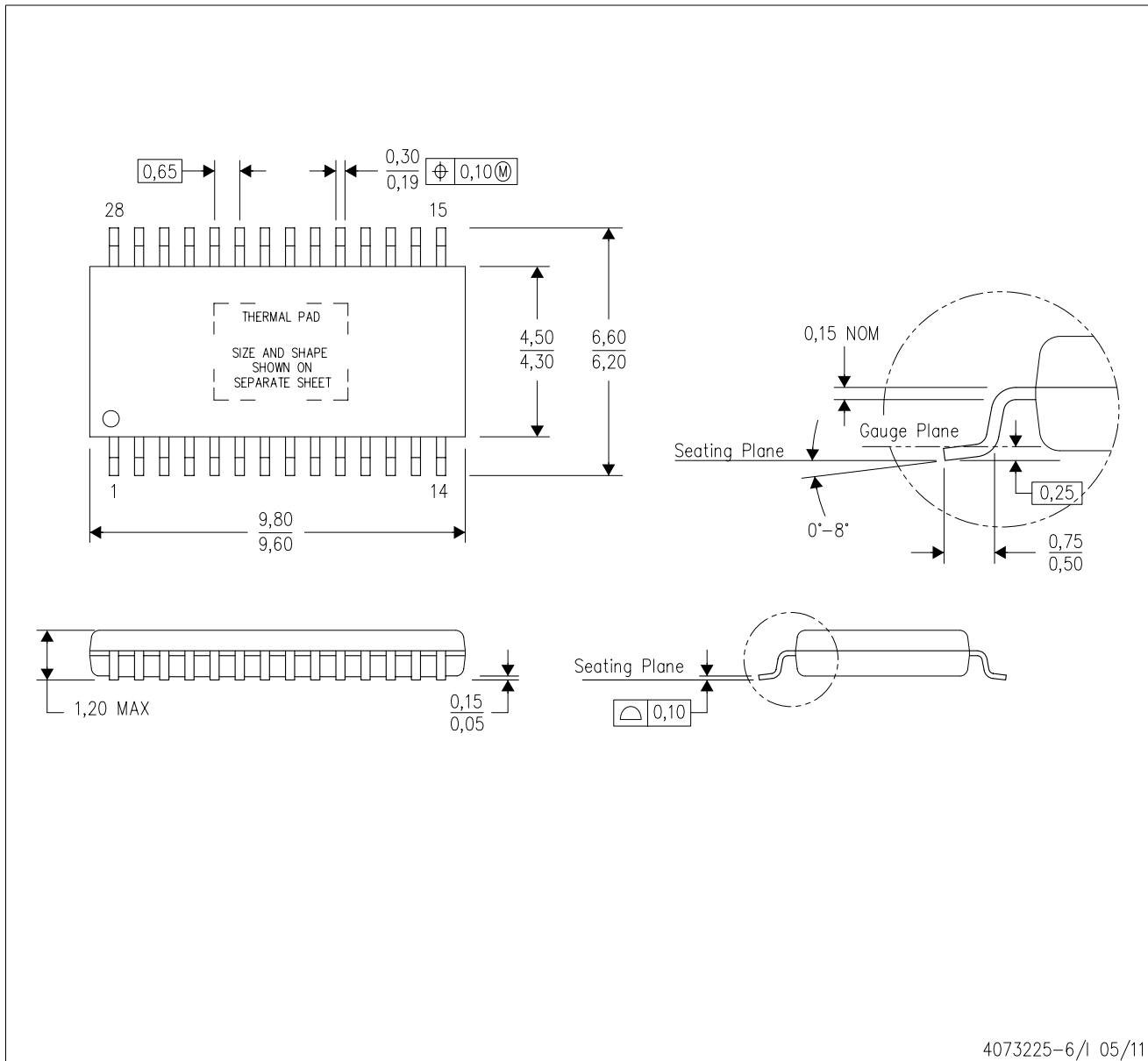

- NOTES:
- All linear dimensions are in millimeters.
 - This drawing is subject to change without notice.
 - Body dimensions do not include mold flash or protrusions. Mold flash and protrusion shall not exceed 0.15 per side.
 - This package is designed to be soldered to a thermal pad on the board. Refer to Technical Brief, PowerPad Thermally Enhanced Package, Texas Instruments Literature No. SLMA002 for information regarding recommended board layout. This document is available at www.ti.com <<http://www.ti.com>>.
 - See the additional figure in the Product Data Sheet for details regarding the exposed thermal pad features and dimensions.
 - Falls within JEDEC MO-153

PowerPAD is a trademark of Texas Instruments.

THERMAL PAD MECHANICAL DATA

PWP (R-PDSO-G28) PowerPAD™ SMALL PLASTIC OUTLINE

THERMAL INFORMATION

This PowerPAD™ package incorporates an exposed thermal pad that is designed to be attached to a printed circuit board (PCB). The thermal pad must be soldered directly to the PCB. After soldering, the PCB can be used as a heatsink. In addition, through the use of thermal vias, the thermal pad can be attached directly to the appropriate copper plane shown in the electrical schematic for the device, or alternatively, can be attached to a special heatsink structure designed into the PCB. This design optimizes the heat transfer from the integrated circuit (IC).

For additional information on the PowerPAD package and how to take advantage of its heat dissipating abilities, refer to Technical Brief, PowerPAD Thermally Enhanced Package, Texas Instruments Literature No. SLMA002 and Application Brief, PowerPAD Made Easy, Texas Instruments Literature No. SLMA004. Both documents are available at www.ti.com.

The exposed thermal pad dimensions for this package are shown in the following illustration.

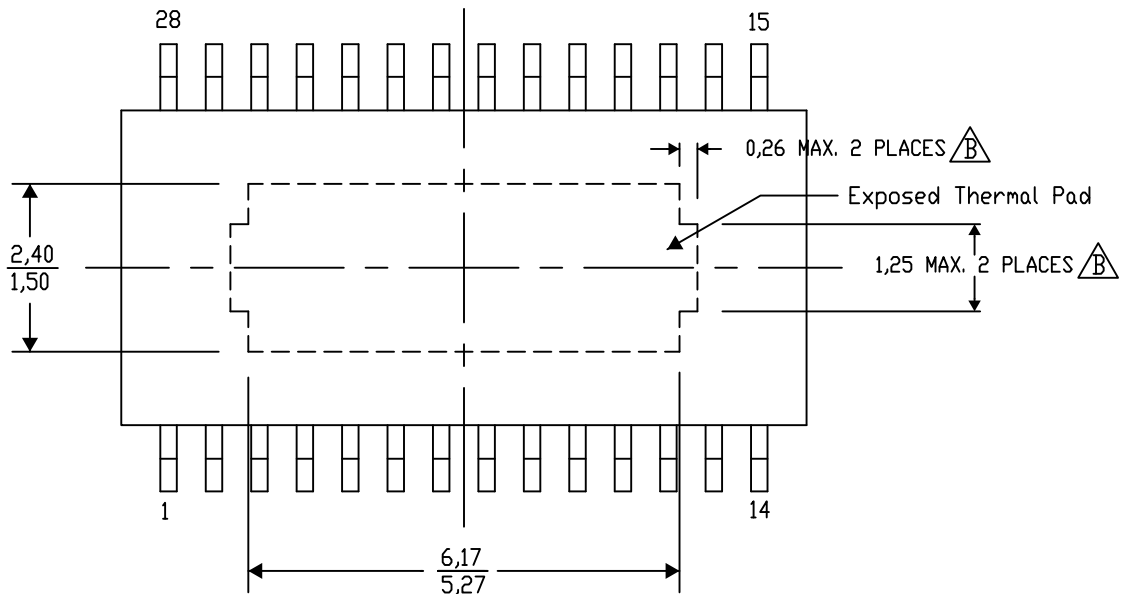

Top View

Exposed Thermal Pad Dimensions

4206332-33/AO 01/16

NOTE: A. All linear dimensions are in millimeters

B. Exposed tie strap features may not be present.

PowerPAD is a trademark of Texas Instruments

PWP (R-PDSO-G28)

PowerPAD™ PLASTIC SMALL OUTLINE

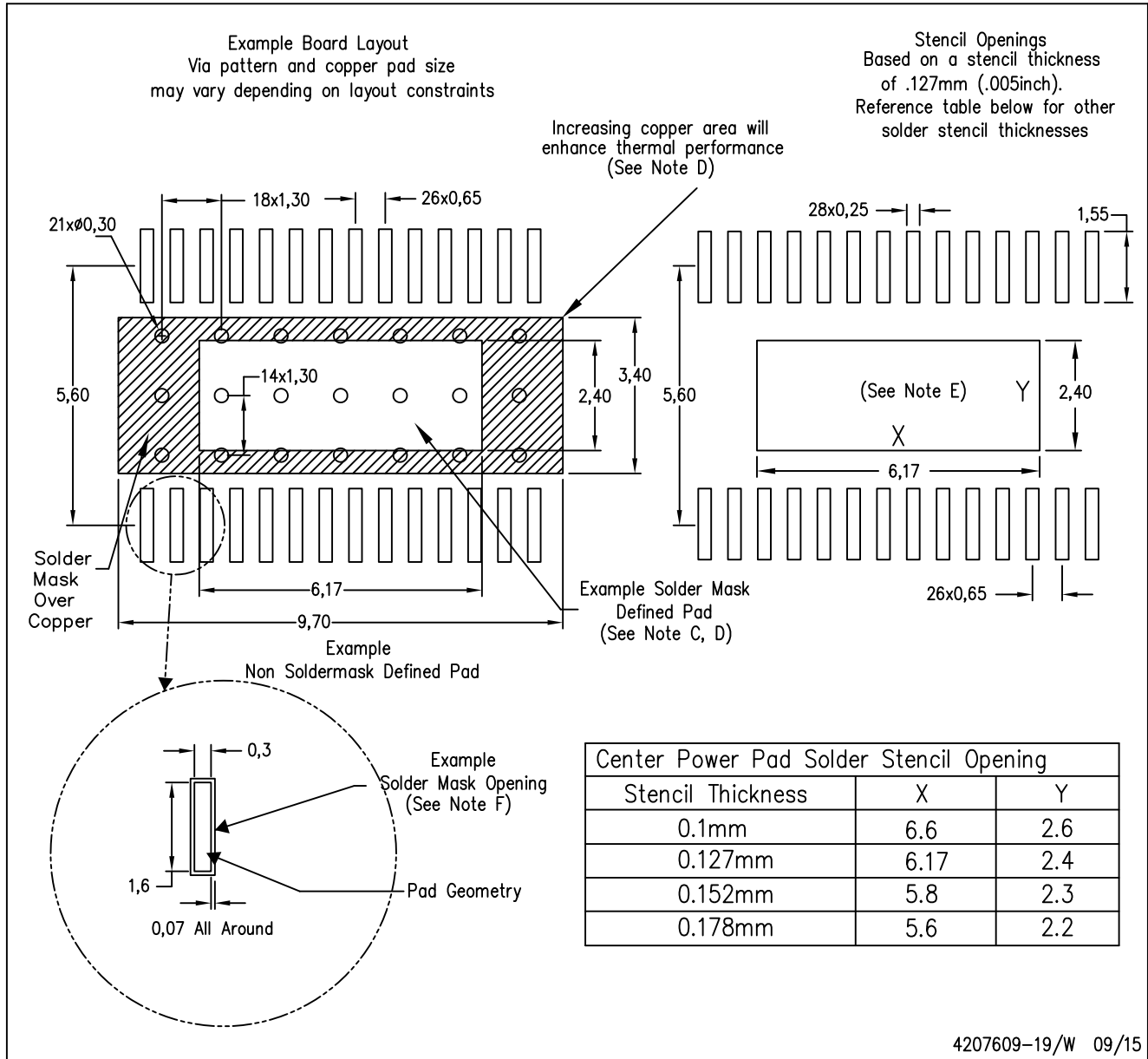

- NOTES:
- A. All linear dimensions are in millimeters.
 - B. This drawing is subject to change without notice.
 - C. Customers should place a note on the circuit board fabrication drawing not to alter the center solder mask defined pad.
 - D. This package is designed to be soldered to a thermal pad on the board. Refer to Technical Brief, PowerPad Thermally Enhanced Package, Texas Instruments Literature No. SLMA002, SLMA004, and also the Product Data Sheets.
 - E. For specific thermal information, via requirements, and recommended board layout. These documents are available at www.ti.com <<http://www.ti.com>>. Publication IPC-7351 is recommended for alternate designs. Laser cutting apertures with trapezoidal walls and also rounding corners will offer better paste release. Customers should contact their board assembly site for stencil design recommendations. Example stencil design based on a 50% volumetric metal load solder paste. Refer to IPC-7525 for other stencil
 - F. Customers should contact their board fabrication site for solder mask tolerances between and around signal pads.

IMPORTANT NOTICE

Texas Instruments Incorporated and its subsidiaries (TI) reserve the right to make corrections, enhancements, improvements and other changes to its semiconductor products and services per JESD46, latest issue, and to discontinue any product or service per JESD48, latest issue. Buyers should obtain the latest relevant information before placing orders and should verify that such information is current and complete. All semiconductor products (also referred to herein as "components") are sold subject to TI's terms and conditions of sale supplied at the time of order acknowledgment.

TI warrants performance of its components to the specifications applicable at the time of sale, in accordance with the warranty in TI's terms and conditions of sale of semiconductor products. Testing and other quality control techniques are used to the extent TI deems necessary to support this warranty. Except where mandated by applicable law, testing of all parameters of each component is not necessarily performed.

TI assumes no liability for applications assistance or the design of Buyers' products. Buyers are responsible for their products and applications using TI components. To minimize the risks associated with Buyers' products and applications, Buyers should provide adequate design and operating safeguards.

TI does not warrant or represent that any license, either express or implied, is granted under any patent right, copyright, mask work right, or other intellectual property right relating to any combination, machine, or process in which TI components or services are used. Information published by TI regarding third-party products or services does not constitute a license to use such products or services or a warranty or endorsement thereof. Use of such information may require a license from a third party under the patents or other intellectual property of the third party, or a license from TI under the patents or other intellectual property of TI.

Reproduction of significant portions of TI information in TI data books or data sheets is permissible only if reproduction is without alteration and is accompanied by all associated warranties, conditions, limitations, and notices. TI is not responsible or liable for such altered documentation. Information of third parties may be subject to additional restrictions.

Resale of TI components or services with statements different from or beyond the parameters stated by TI for that component or service voids all express and any implied warranties for the associated TI component or service and is an unfair and deceptive business practice. TI is not responsible or liable for any such statements.

Buyer acknowledges and agrees that it is solely responsible for compliance with all legal, regulatory and safety-related requirements concerning its products, and any use of TI components in its applications, notwithstanding any applications-related information or support that may be provided by TI. Buyer represents and agrees that it has all the necessary expertise to create and implement safeguards which anticipate dangerous consequences of failures, monitor failures and their consequences, lessen the likelihood of failures that might cause harm and take appropriate remedial actions. Buyer will fully indemnify TI and its representatives against any damages arising out of the use of any TI components in safety-critical applications.

In some cases, TI components may be promoted specifically to facilitate safety-related applications. With such components, TI's goal is to help enable customers to design and create their own end-product solutions that meet applicable functional safety standards and requirements. Nonetheless, such components are subject to these terms.

No TI components are authorized for use in FDA Class III (or similar life-critical medical equipment) unless authorized officers of the parties have executed a special agreement specifically governing such use.

Only those TI components which TI has specifically designated as military grade or "enhanced plastic" are designed and intended for use in military/aerospace applications or environments. Buyer acknowledges and agrees that any military or aerospace use of TI components which have **not** been so designated is solely at the Buyer's risk, and that Buyer is solely responsible for compliance with all legal and regulatory requirements in connection with such use.

TI has specifically designated certain components as meeting ISO/TS16949 requirements, mainly for automotive use. In any case of use of non-designated products, TI will not be responsible for any failure to meet ISO/TS16949.

Products

Audio	www.ti.com/audio
Amplifiers	amplifier.ti.com
Data Converters	dataconverter.ti.com
DLP® Products	www.dlp.com
DSP	dsp.ti.com
Clocks and Timers	www.ti.com/clocks
Interface	interface.ti.com
Logic	logic.ti.com
Power Mgmt	power.ti.com
Microcontrollers	microcontroller.ti.com
RFID	www.ti-rfid.com
OMAP Applications Processors	www.ti.com/omap
Wireless Connectivity	www.ti.com/wirelessconnectivity

Applications

Automotive and Transportation	www.ti.com/automotive
Communications and Telecom	www.ti.com/communications
Computers and Peripherals	www.ti.com/computers
Consumer Electronics	www.ti.com/consumer-apps
Energy and Lighting	www.ti.com/energy
Industrial	www.ti.com/industrial
Medical	www.ti.com/medical
Security	www.ti.com/security
Space, Avionics and Defense	www.ti.com/space-avionics-defense
Video and Imaging	www.ti.com/video

TI E2E Community

e2e.ti.com