



Features

- Universal AC input / Full range
- 3 pole AC inlet IEC320-C14, Class I power unit
- No load power consumption < 0.075W
- **Energy efficiency Level VI**
- Comply with EISA 2007/DoE, EU ErP and meet CoC Version 5
- Protections: Short circuit / Overload / Over voltage
- Fully enclosed plastic case
- Pass LPS
- 2 years warranty

Applications

- Consumer electronic devices
- Telecommunication devices
- Office facilities
- Industrial equipments

Description

GS15A is a highly reliable, 15W desktop style single-output green adaptor series. This product is a class I power unit (with FG), equipped with a standard IEC320-C14 AC inlet and adopting the input range from 90VAC to 264VAC. The entire series supplies different models with output voltages ranging between 5VDC and 48VDC that can satisfy the demands for various types of consumer electronic devices.

With the efficiency up to 87% and the extremely low no-load power consumption below 0.075W, GS15A is compliant with USA EISA 2007/DoE, EU ErP, and meet Code of Conduct(CoC) Version 5. The supreme feature allows the adaptor to save the energy when it is either under the operating mode or the standby mode.

The entire series utilizes the 94V-0 flame retardant plastic case. GS15A is certified for the international safety regulations.

Model Encoding

GS 15 A - 1 P1J

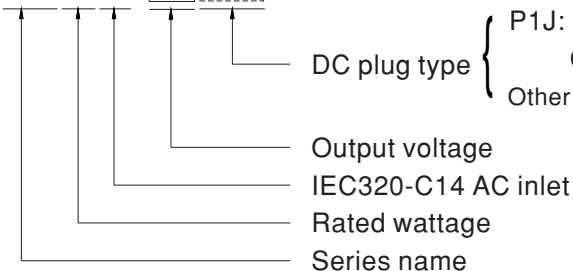

DC plug type { P1J: Plug for standard model, 2.1 ψ × 5.5 ψ × 11mm, C+ tuning fork type
Other options available by customer requested (see Page 4~5)

SPECIFICATION

ORDER NO.	GS15A-1P1J	GS15A-11P1J	GS15A-2P1J	GS15A-3P1J	GS15A-4P1J	GS15A-5P1J	GS15A-6P1J	GS15A-8P1J		
OUTPUT	SAFETY MODEL NO.	GS15A-1	GS15A-1-1	GS15A-2	GS15A-3	GS15A-4	GS15A-5	GS15A-6	GS15A-8	
	DC VOLTAGE <small>Note.2</small>	5V	7.5V	9V	12V	15V	18V	24V	48V	
	RATED CURRENT	2.40A	1.60A	1.66A	1.25A	1.00A	0.83A	0.625A	0.31A	
	CURRENT RANGE	0 ~ 2.40A	0 ~ 1.60A	0 ~ 1.66A	0 ~ 1.25A	0 ~ 1.00A	0 ~ 0.83A	0 ~ 0.625A	0 ~ 0.31A	
	RATED POWER	12W	12W	15W	15W	15W	15W	15W	15W	
	RIPPLE & NOISE (max.) <small>Note.3</small>	50mVp-p	80mVp-p	80mVp-p	80mVp-p	100mVp-p	120mVp-p	150mVp-p	240mVp-p	
	VOLTAGE TOLERANCE <small>Note.4</small>	±5.0%	±5.0%	±5.0%	±3.0%	±3.0%	±3.0%	±2.0%	±2.0%	
	LINE REGULATION <small>Note.5</small>	±0.5%	±0.5%	±0.5%	±0.5%	±0.5%	±0.5%	±0.5%	±0.5%	
	LOAD REGULATION <small>Note.6</small>	±5.0%	±5.0%	±5.0%	±3.0%	±3.0%	±3.0%	±2.0%	±2.0%	
	SETUP, RISE, HOLD UP TIME	3000ms, 50ms, 16ms at full load								
INPUT	VOLTAGE RANGE	90 ~ 264VAC 135 ~ 370VDC								
	FREQUENCY RANGE	47 ~ 63Hz								
	EFFICIENCY (Typ.)	80%	82.5%	85%	85%	85%	85%	85.5%	87%	
	AC CURRENT	0.5A / 100VAC								
	INRUSH CURRENT (max.)	Cold start 30A/ 115VAC 50A/ 230VAC								
	LEAKAGE CURRENT(max.)	0.25mA / 240VAC								
PROTECTION	OVERLOAD	105 ~ 250% rated output power Protection type : Hiccup mode, recovers automatically after fault condition is removed								
	OVER VOLTAGE	>120% rated output voltage Protection type : Clamp by zener diode								
	ENVIRONMENT	WORKING TEMP. 0 ~ +50°C (Refer to "Derating Curve") WORKING HUMIDITY 20% ~ 90% RH non-condensing STORAGE TEMP., HUMIDITY -20 ~ +85°C, 10 ~ 95% RH non-condensing TEMP. COEFFICIENT ±0.03% / °C (0 ~ 40°C) VIBRATION 10 ~ 500Hz, 2G 10min./1cycle, period for 60min. each along X, Y, Z axes								
SAFETY & EMC <small>(Note. 7)</small>	SAFETY STANDARDS	UL60950-1, CSA C22.2, TUV EN60950-1, EAC TP TC 004 approved								
	WITHSTAND VOLTAGE	I/P-O/P:3KVAC, I/P-FG:1.5KVAC								
	ISOLATION RESISTANCE	I/P-O/P, I/P-FG:100M Ohms / 500VDC / 25°C / 70% RH								
	EMC EMISSION	Parameter	Standard					Test Level / Note		
		Conducted emission	EN55032/CISPR32/FCC PART 15 / CISPR22, CAN ICES-3(B)/NMB-3(B)					Class B		
		Radiated emission	EN55032/CISPR32/FCC PART 15 / CISPR22, CAN ICES-3(B)/NMB-3(B)					Class B		
		Harmonic current	EN61000-3-2					Class A		
		Voltage flicker	EN61000-3-3					-----		
	EMC IMMUNITY	Parameter	Standard					Test Level / Note		
		ESD	EN61000-4-2					Level 3, 8KV air; Level 2, 4KV contact		
RF field susceptibility		EN61000-4-3					Level 2, 3V/m			
EFT bursts		EN61000-4-4					Level 2, 1KV			
Surge susceptibility		EN61000-4-5					Level 3, 1KV/L-N 2KV/L,N-PE			
Conducted susceptibility		EN61000-4-6					Level 2, 3V			
Magnetic field immunity		EN61000-4-8					Level 1, 1A/m			
Voltage dips , interruption		EN61000-4-11					>95% dip 0. 5 periods, 30% dip 25 periods, >95% interruptions 250 periods			
OTHERS	MTBF	500Khrs min. MIL-HDBK-217F(25°C)								
	DIMENSION	100*58.5*32.8mm (L*W*H)								
	PACKING	190g ; 90pcs / 18Kg / CARTON								
CONNECTOR	PLUG	See page 4~5 ; Other type available by customer requested								
	CABLE	See page 4~5 ; Other type available by customer requested								
NOTE	<p>1.All parameters are specified at 230VAC input, rated load, 25°C 70% RH ambient.</p> <p>2.DC voltage: The output voltage set at point measure by plug terminal & 50% load.</p> <p>3.Ripple & noise are measured at 20MHz by using a 12" twisted pair terminated with a 0.1µf & 47µf capacitor.</p> <p>4.Tolerance: includes set up tolerance, line regulation, load regulation.</p> <p>5.Line regulation is measured from low line to high line at rated load.</p> <p>6.Load regulation is measured from 0% to 100% rated load.</p> <p>7.The power supply is considered as an independent unit, but the final equipment still need to re-confirm that the whole system complies with the EMC directives. For guidance on how to perform these EMC tests, please refer to "EMI testing of component power supplies." (as available on http://www.meanwell.com)</p>									

■ Derating Curve

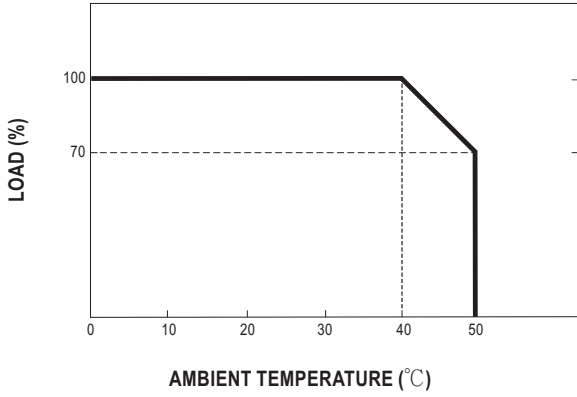

■ Static Characteristics

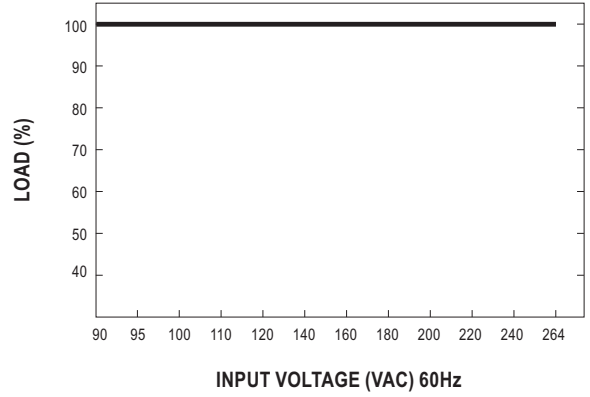

■ Mechanical Specification



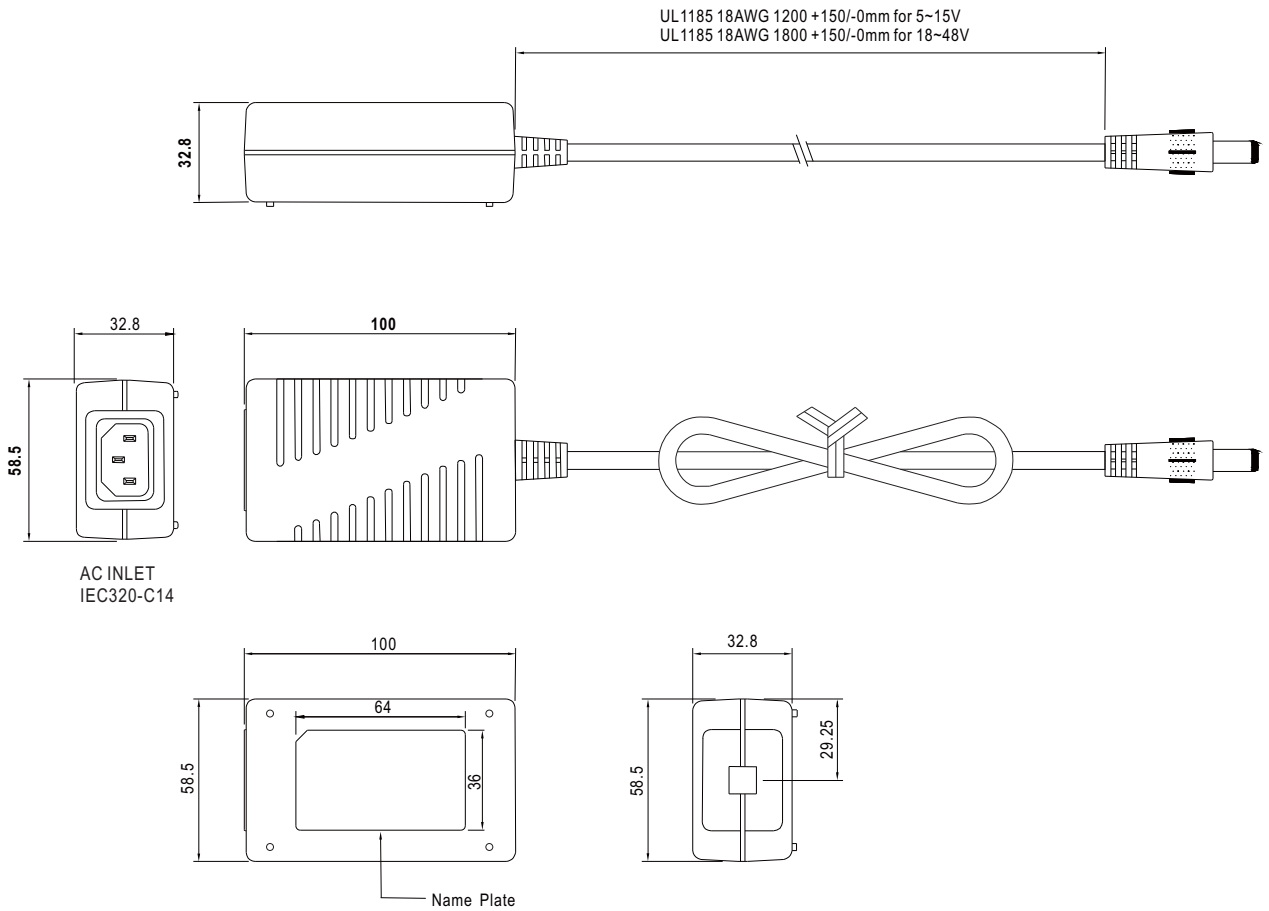

Unit:mm







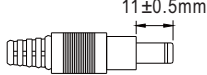



■ DC output plug

☉ Standard plug: P1J

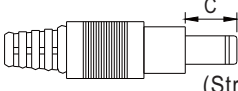
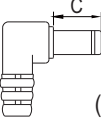
Unit:mm

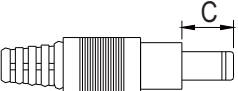
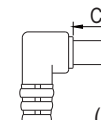
P1J		Pin Assignment
		
		Outside  Inside

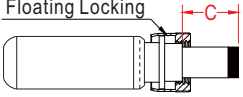
☉ Optional DC plug:

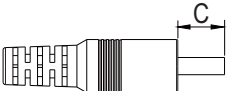
Tuning Fork Style		Type No.	A	B	C	
			OD	ID	L	
			P1I	5.5	2.1	9.5
		(Straight)	P1L	5.5	2.5	9.5
		(Right-angled)	P1M	5.5	2.5	11.0
			P1IR	5.5	2.1	9.5
			P1JR	5.5	2.1	11.0
			P1LR	5.5	2.5	9.5
		P1MR	5.5	2.5	11.0	
Barrel Style		Type No.	A	B	C	
			OD	ID	L	
			P2I	5.5	2.1	9.5
		(Straight)	P2J	5.5	2.1	11.0
		(Right-angled)	P2L	5.5	2.5	9.5
			P2M	5.5	2.5	11.0
			P2IR	5.5	2.1	9.5
			P2JR	5.5	2.1	11.0
			P2LR	5.5	2.5	9.5
			P2MR	5.5	2.5	11.0
Lock Style		Type No.	A	B	C	
			OD	ID	L	
			P2S(S761K)	5.53	2.03	12.06
		SWITCHCRAFT original or equivalent	P2K(761K)	5.53	2.54	12.06
			P2C(S760K)	5.53	2.03	9.52
			P2D(760K)	5.53	2.54	9.52
Min. Pin Style		Type No.	A	B	C	
			OD	ID	L	
			P3A	2.35	0.7	11.0
		EIAJ equivalent	P3B	4.0	1.7	11.0
			P3C	4.75	1.7	11.0

Center Pin Style	Type No.	A	B	C	D
		OD	ID	L	Center Pin
	P4A	5.5	3.4	11.0	1.0
	P4B	6.5	4.4	11.0	1.4
	P4C	7.4	5.1	11.0	0.6
Min. DIN 3 Pin with Lock (male)	Type No.	Pin Assignment			
	R6B	PIN No.	Output		
		1	+Vo		
		2	-Vo		
		3	+Vo		
Min. DIN 4 Pin with Lock (male)	Type No.	Pin Assignment			
	R7B	PIN No.	Output		
		1	+Vo		
		2	-Vo		
		3	-Vo		
4	+Vo				
Min. DIN 4 Pin with Lock (female)	Type No.	Pin Assignment			
	R7BF	PIN No.	Output		
		1	+Vo		
		2	-Vo		
		3	-Vo		
4	+Vo				
Stripped and tinned leads	Type No.	Pin Assignment			
<p>Length of Land L1 by request (MW's standard length, L: <u>25</u> mm, L1: <u>10</u> mm)</p>	by customer	PIN No.	Output		
		1 (White)	+Vo		
		2 (Black)	-Vo		

■ **Installation Manual**

Please refer to : <http://www.meanwell.com/manual.html>