

## Data sheet

Commercial Art.No.: 25.641.3853.0

PCB connector 8513 B / 8 F OB

PCB female connector with screw connection with rising cage clamp system, 8 poles, max. cross section: 1.5 mm<sup>2</sup>, pitch: 3.5 mm, type of packing: carton, color: grey

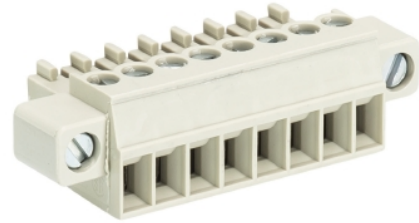

Commercial Art.No.	25.641.3853.0
EAN	4015573540859
Order Unit	50

Certificates / Approvals



## Technical data

### General

Modular spacing	3.5 mm
Connection type	screw connection
Soldering process	None
Packaging	Carton
Number of poles	8
Marking	No
Fastening	Flange
Mating direction towards connector	180°

### Technical data

Nominal cross section	1.5 mm <sup>2</sup>
Rated current	8 A
Overvoltage Category I	690 V
Overvoltage Category II	250 V
Overvoltage Category III	125
Rated impulse voltage	2.5 kV
Wire strip length	6.5 mm

### Connection Data

Minimum cross section solid	0.14 mm <sup>2</sup>
Maximum cross section solid	1.5 mm <sup>2</sup>
Minimum cross section fine stranded	0.14 mm <sup>2</sup>
Maximum cross section fine stranded	1.5 mm <sup>2</sup>
Wire strip length	6.5 mm

### Technical Data UL/CSA

Cross section UL	30-16 AWG
------------------	-----------

Voltage UL	300 V
Current field wiring	8 A
Current factory wiring	8 A
Cross section CSA	22-14 AWG
Voltage CSA	300 V
Current CSA	5 A

#### Other

Type of insulation material	Thermoplastic
Color	Grey
Height	11.1 mm
Length	38.4 mm
Depth	15.5 mm
Material attachment screw	Steel
Material contact base	CuSn
Material contact surface	Sn

#### Classification

ECLASS 11	
ECLASS 8.1	27440402
ETIM 7.0	EC002637
ETIM 6.0	EC002637
ETIM 5.0	EC002637
ETIM 4.0	EC002637

#### Product compliance

ROHS conformity status	Compliant/Exempted
ROHS exceptions	III-6(c)
REACH-SVHC conformity status	Duty-To-Declare
REACH-SVHC substances	Lead
REACH-SVHC CAS numbers	7439-92-1

#### Fits with

Commercial Art.No.:	Article-type description:	Description:
25.647.3853.0	PCB pin header 8513 S / 8 WF OB	PCB pin header with pin header, connection method depends on used socket part , 8 poles, pitch: 3.5 mm, type of packing: carton, color: grey
25.646.3853.0	PCB pin header 8513 S / 8 GF OB	PCB pin header with pin header, connection method depends on used socket part , 8 poles, pitch: 3.5 mm, type of packing: carton, color: grey

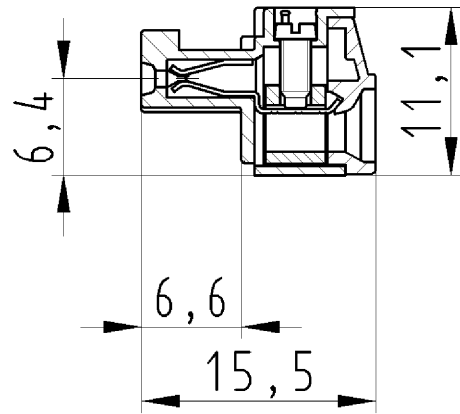
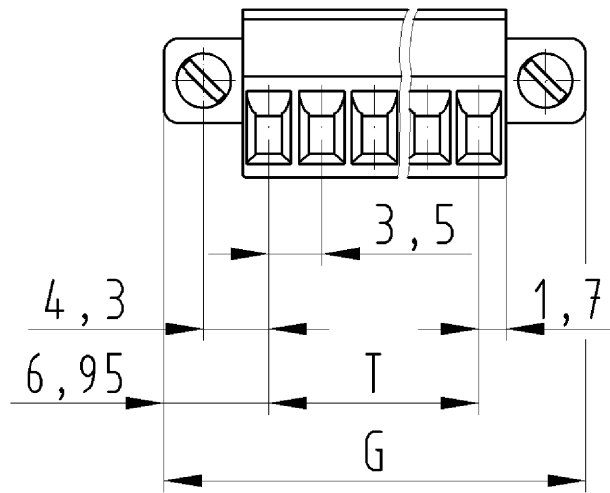

für folgende Tabellen-Zchnng.  
 25.641.3253.0 8513 B/ ... F OB

LP-Steckklemme  
 25.641.3253.0 10W  
 22.10.2007 DÜT  
 M2:1