

DETAILS

Product Number	CP12942_LARISA-O-CLIP8
Family	Larisa
Type	Assembly
Color	black
Diameter	9,9 + 9,9 mm
Height	7,5 mm
Style	square
Optic Material	PMMA
Holder Material	
Fastening	clips
Status	production ready
ROHS Compliant	Yes
Date Updated	9/12/2016



OPTICAL PROPERTIES

LED	Viewing Angle	Light Beam	Efficiency	cd/lm	Connector
XB-D	39+21 deg	Oval	79 %	2.200	-
XP-G	39+25 deg	Oval	83 %	2.050	-
XQ-E	40+17 deg	Oval	82 %	2.800	-
XQ-E HI	41+14 deg	Oval	76 %	3.500	-
H35C0 (LEMWA33)	39+27 deg	Oval	81 %	1.840	-
H35B0 (LEMWA32)	38+22 deg	Oval	82 %	2.200	-
LUXEON A	39+26 deg	Oval	81 %	1.900	-
LUXEON Rebel ES	39+25 deg	Oval	82 %	2.000	-
LUXEON Rebel	40+18 deg	Oval	84 %	2.700	-
LUXEON Z	41+14 deg	Oval	81 %	3.540	-
LUXEON Z ES	40+18 deg	Oval	86 %	2.800	-
LUXEON Rebel Plus	40+19 deg	Oval	83 %	2.600	-
NCSxx19A	41+19 deg	Oval	81 %	2.250	-
NVSxx19A	40+24 deg	Oval	79 %	1.850	-
NF2x757A	41+33 deg	Oval	78 %	1.950	-
NF2x757G	42+25 deg	Oval	76 %	1.530	-
Oslon Square EC	40+22 deg	Oval	78 %	1.950	-
Oslon SSL 150	39+19 deg	Oval	84 %	2.900	-
Duris S5 (2 chip)	26+41 deg	Oval	85 %	1.800	-
Oslon SSL 80	40+17 deg	Oval	77 %	2.530	-

Relative intensity of CP12942_LARISA-O-CLIP8_(XQ-E_HI)

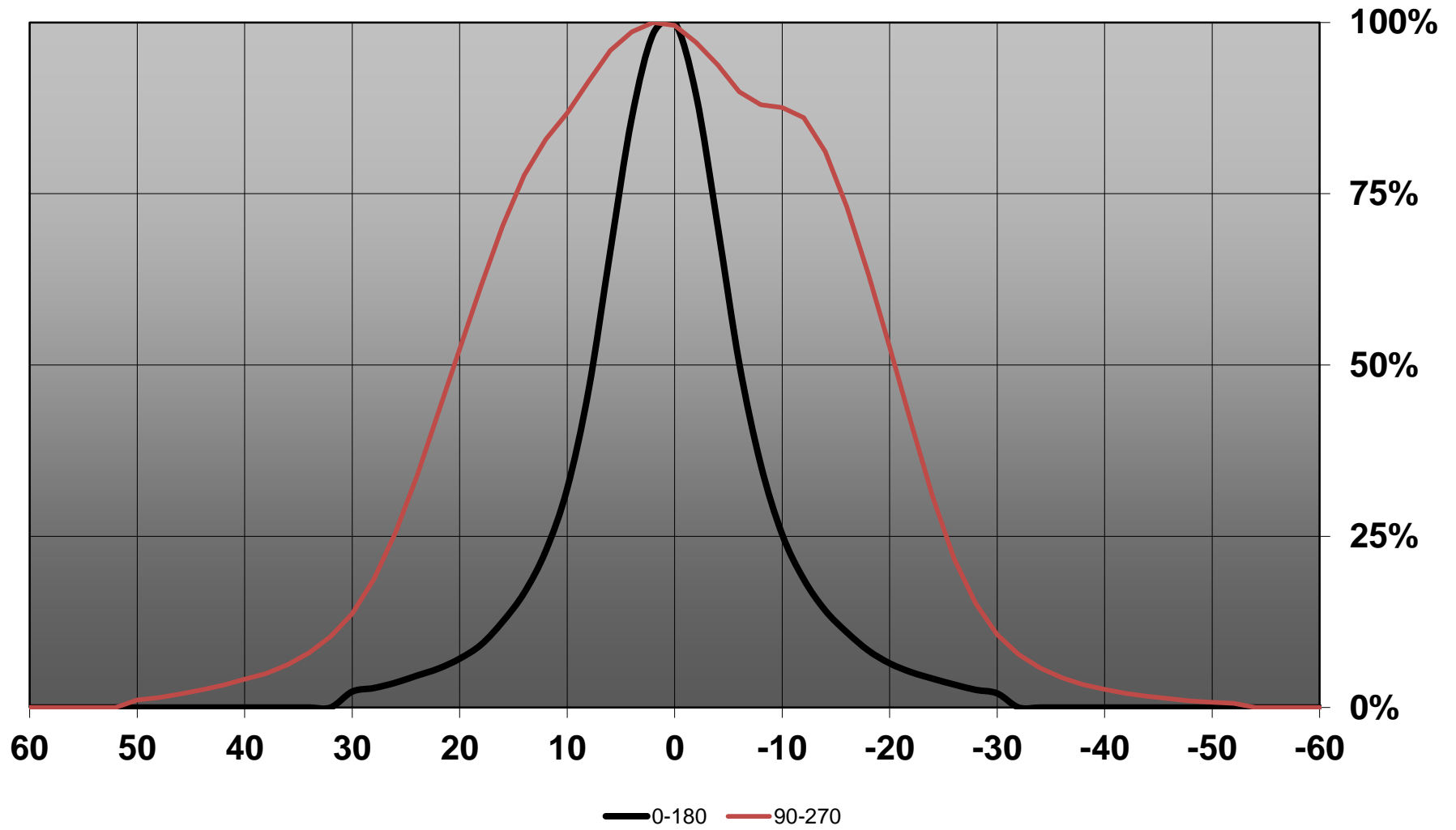

Relative intensity of CP12942_LARISA-O-CLIP8_(Luxeon Z)

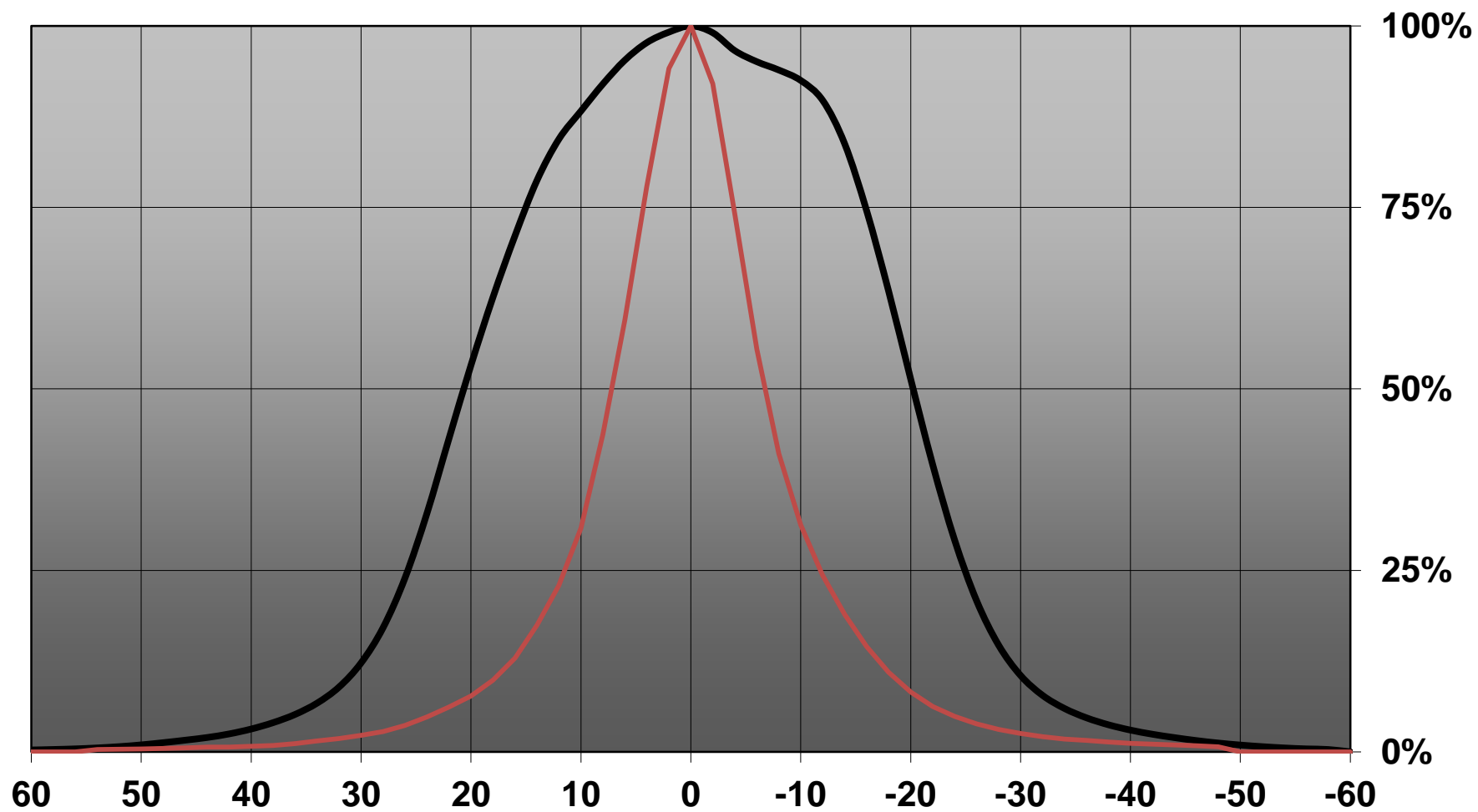

Relative intensity of CP12942_LARISA-O-CLIP8_(NF2757G)

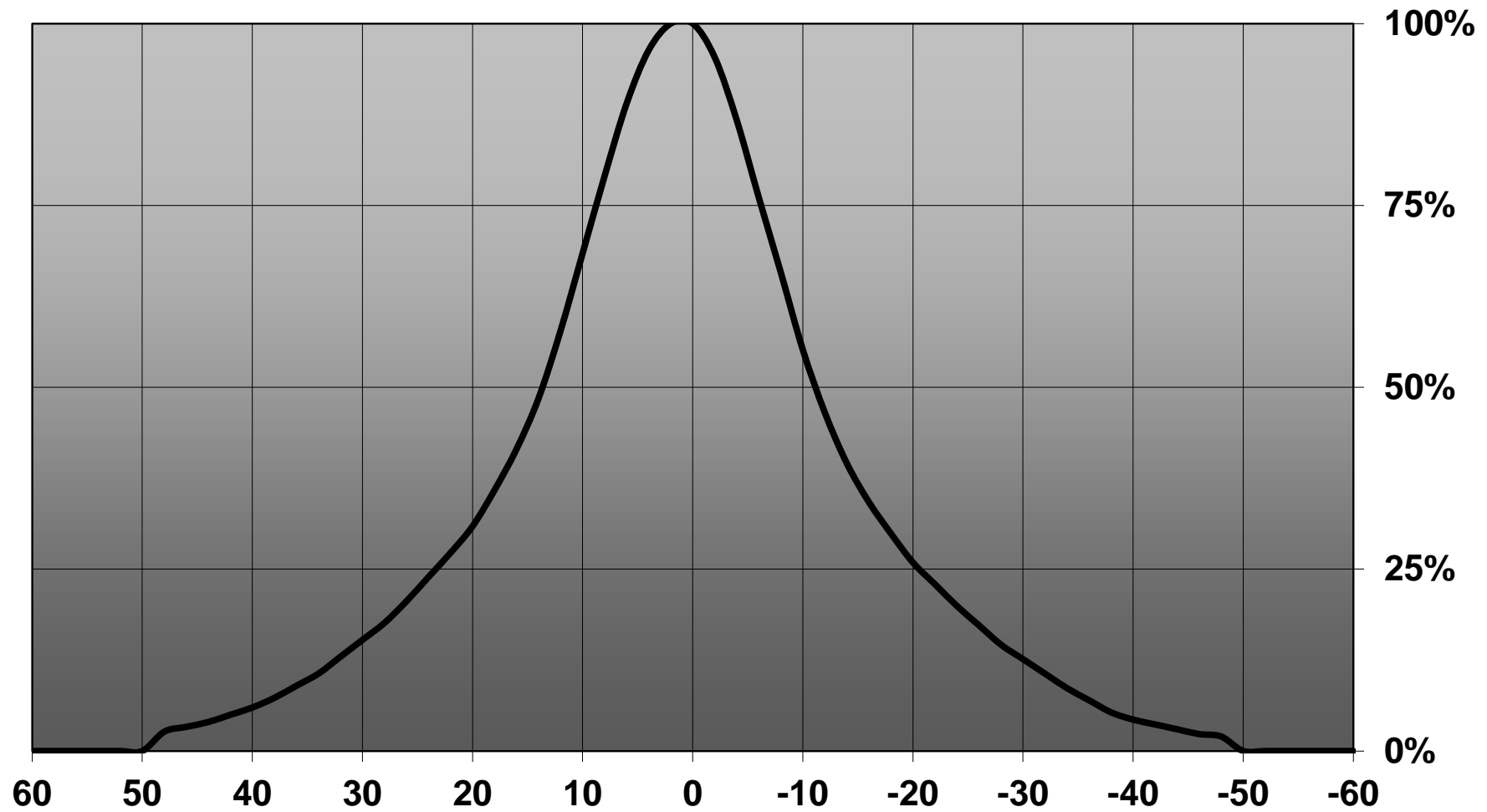

Relative intensity of CP12942_LARISA-O-CLIP8_(SSL80)

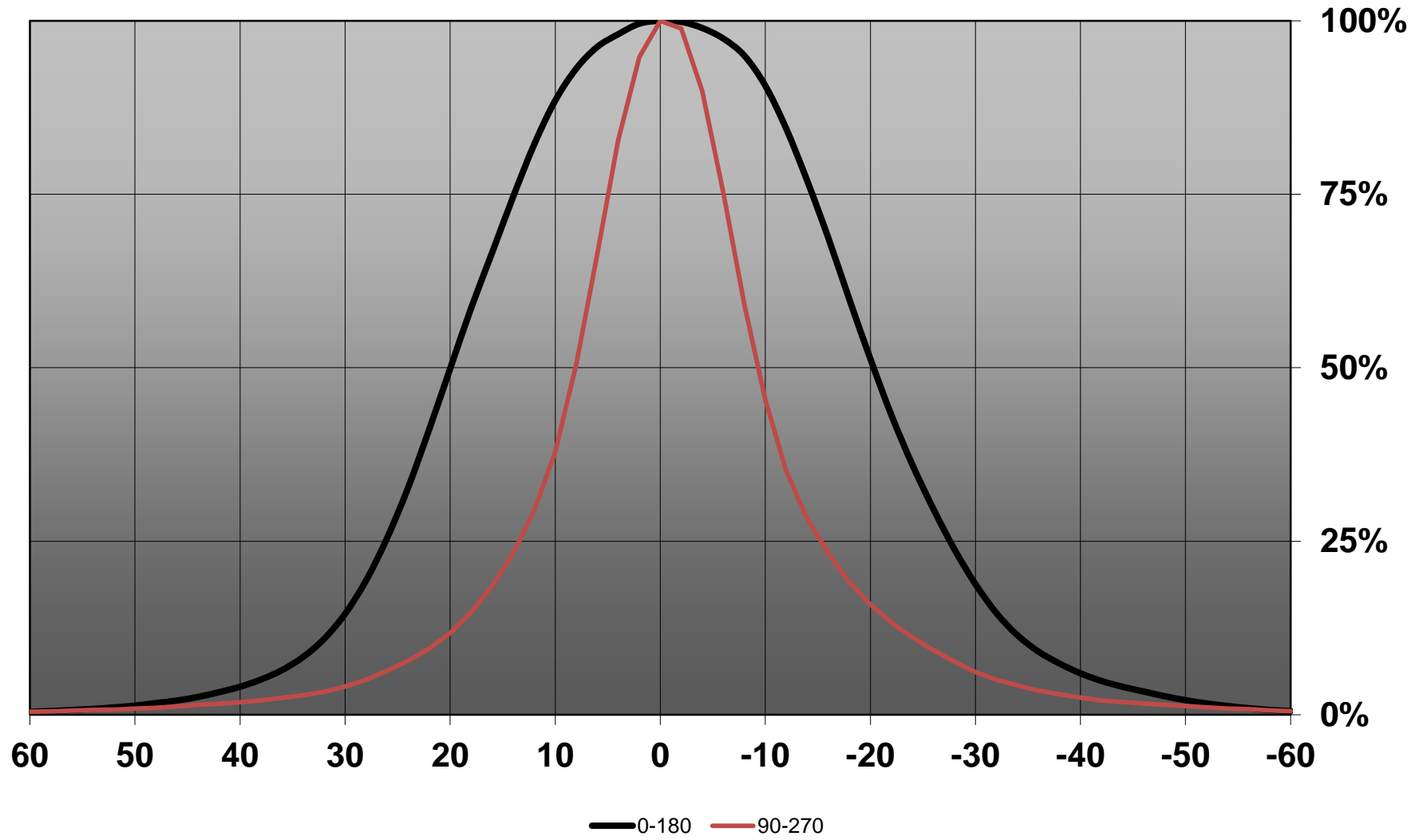

D

C

B

A

4

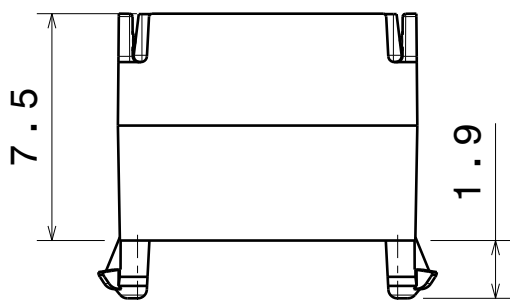

Front view

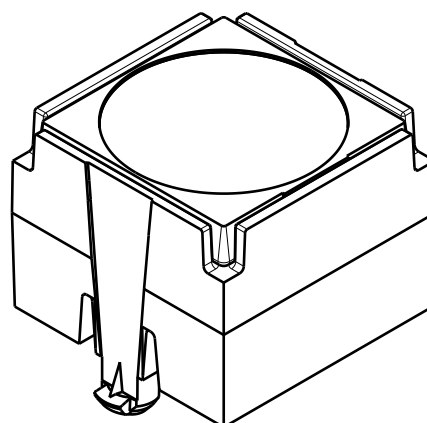
Isometric view
Scale: 4:1

3

9.9

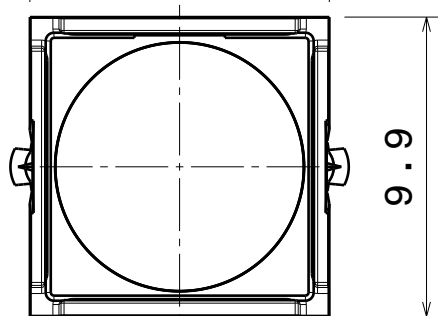

Top view

8.6

c / c

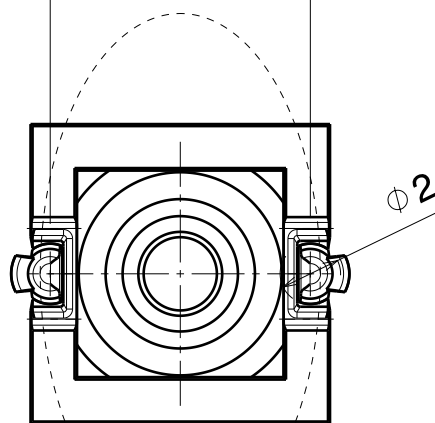

Bottom view

Oval beam direction

2

2

INDEX	PART NO	DESCRIPTION	MATERIAL	COLOUR
1	-	LARISA lens	PMMA	
2	C12907	LARISA-HOLDER-CLIP8	PC	black

Tolerances if not otherwise shown
According to DIN ISO 2768-1
Linear measures:
Up to 30mm class M, otherwise class C.
According to DIN ISO 2768-2
Form and position: class L

LEDiL

Ledil Oy
Salorankatu 10
FIN 24240 SALO
Finland

THIRD ANGLE PROJECTION:

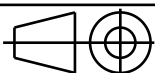

DRAWING TITLE

LARISA-CLIP8

This drawing is the property
of LEDiL Oy. It may not be
reproduced, copied or
communicated without a written
agreement with LEDiL Oy.

SIZE PART NUMBER

A4

-

SCALE 4:1 WEIGHT 0,6 g SHEET 1/1

1

1

D

A

Luminaire: LEDiL Oy LARISA-O_XB-D_(CLIP8&CLIP16) Eff.79.8%
Lamps: 1 x XB-D (91.7428lm@250mA)

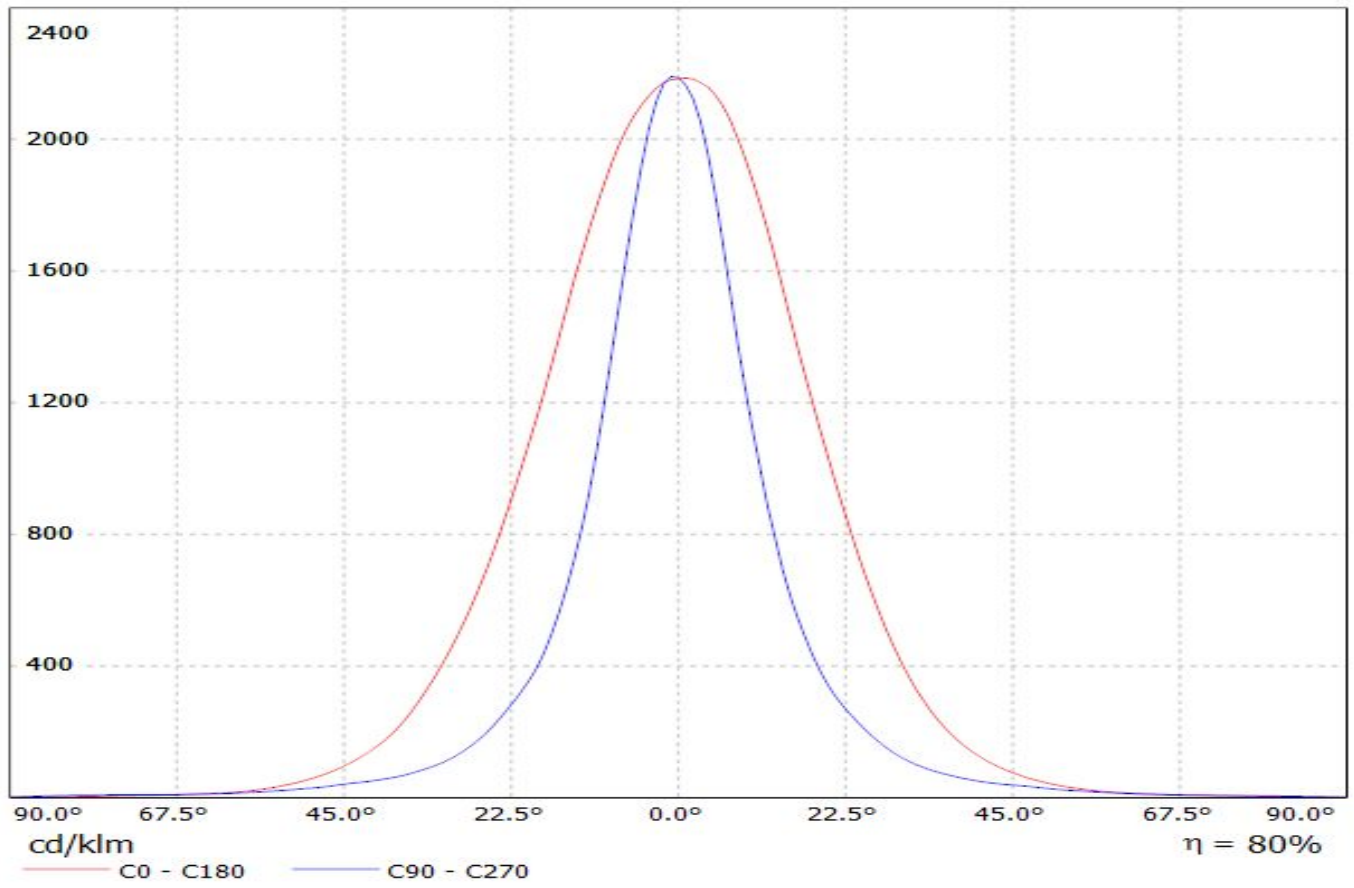

Luminaire: LEDiL Oy LARISA-O_XP-G_(CLIP8&CLIP16) Eff.82.9%
Lamps: 1 x XP-G (62.2075lm@250mA)

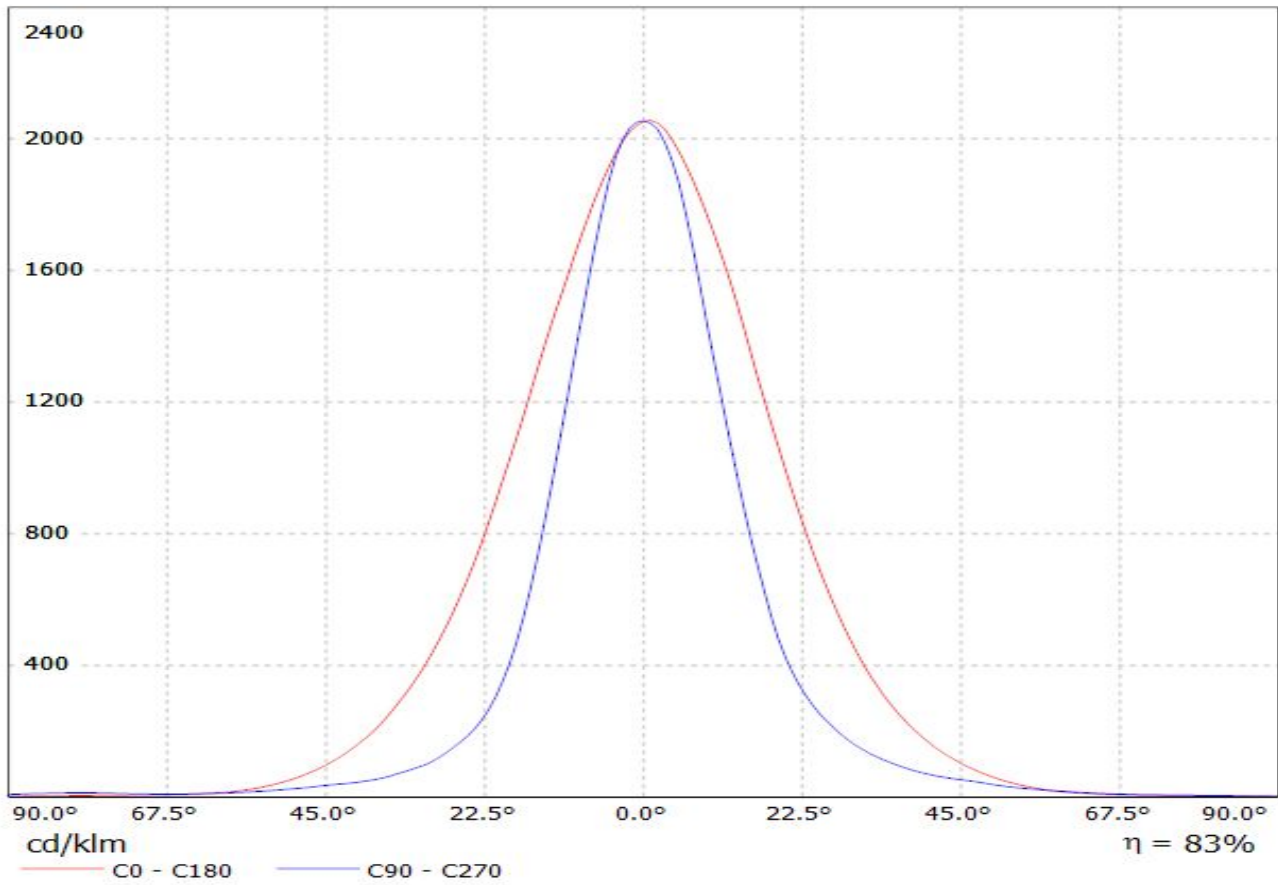

Luminaire: LEDiL Oy CP12942_LARISA-O-CLIP8_(XQ-E)

Lamps: 1 x Cree XQ-E_(XQEAWT-0-7B1-Q40-0H-00001)_81.8467lm@250mA_P=0.765444W_I=250mA

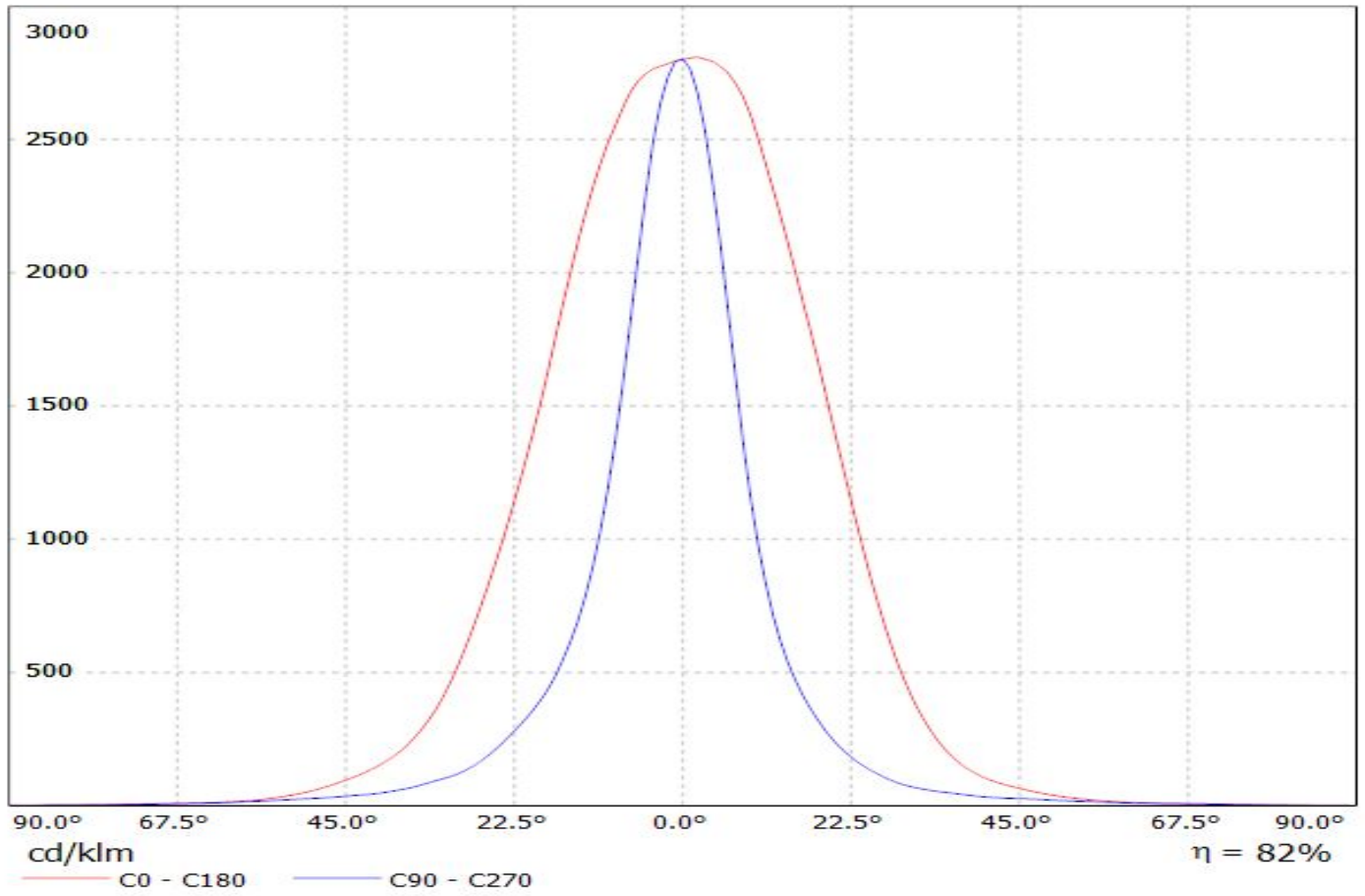

**LEDiL Oy CP12942_LARISA-O-CLIP8_(3535_Ceramic) Eff.80.6% / LDC
(Linear)**

Luminaire: LEDiL Oy CP12942_LARISA-O-CLIP8_(3535_Ceramic) Eff.80.6%
Lamps: 1 x LG 3535 Ceramic (95lm@250mA)

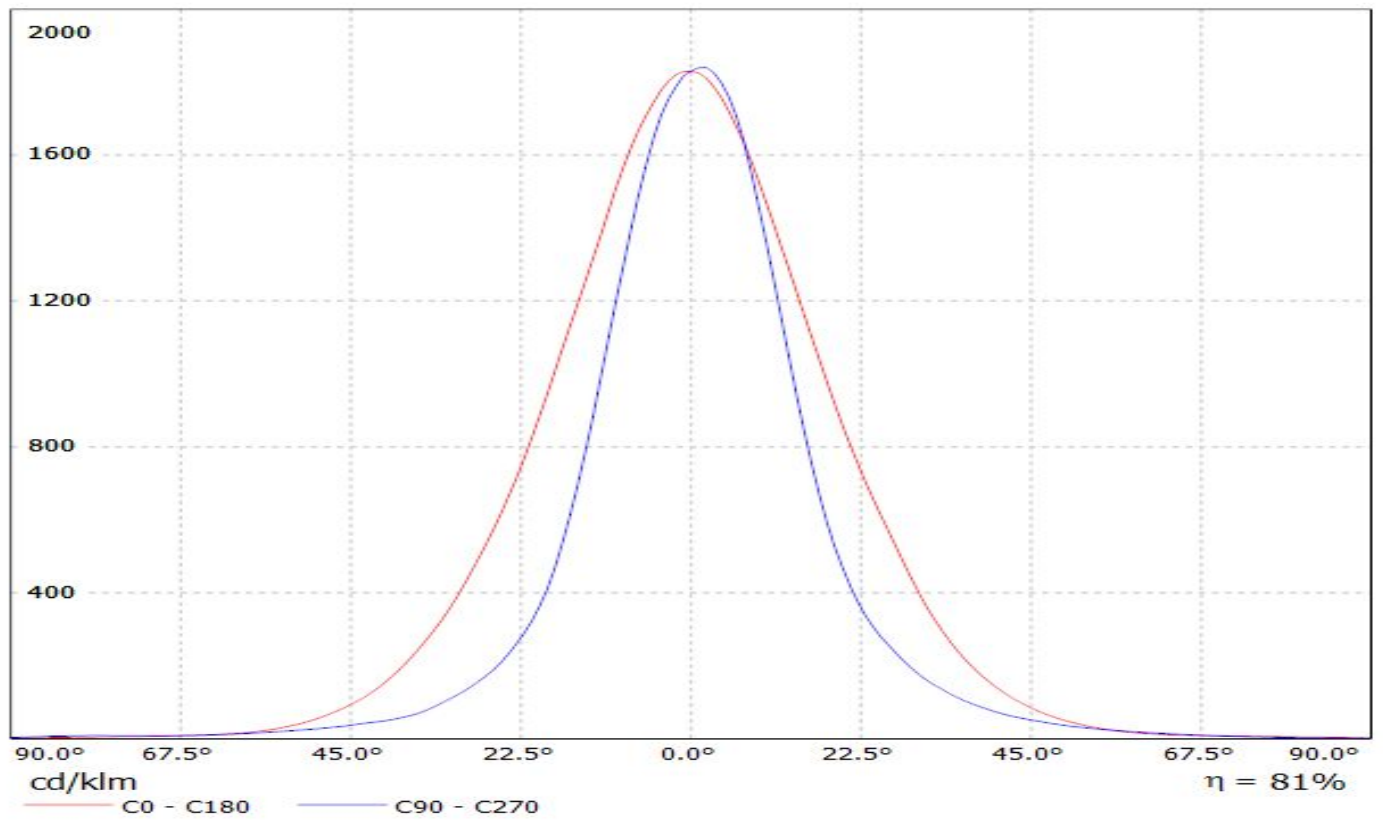

LEDiL Oy CP12942_LARISA-O-CLIP8/CP12943_LARISA-O-CLIP16_ (LG3535_2W) Eff.81.5% / LDC (Linear)

Luminaire: LEDiL Oy CP12942_LARISA-O-CLIP8/CP12943_LARISA-O-CLIP16_(LG3535_2W) Eff.81.5%
Lamps: 1 x LG3535_2W (97.3629lm@250mA)

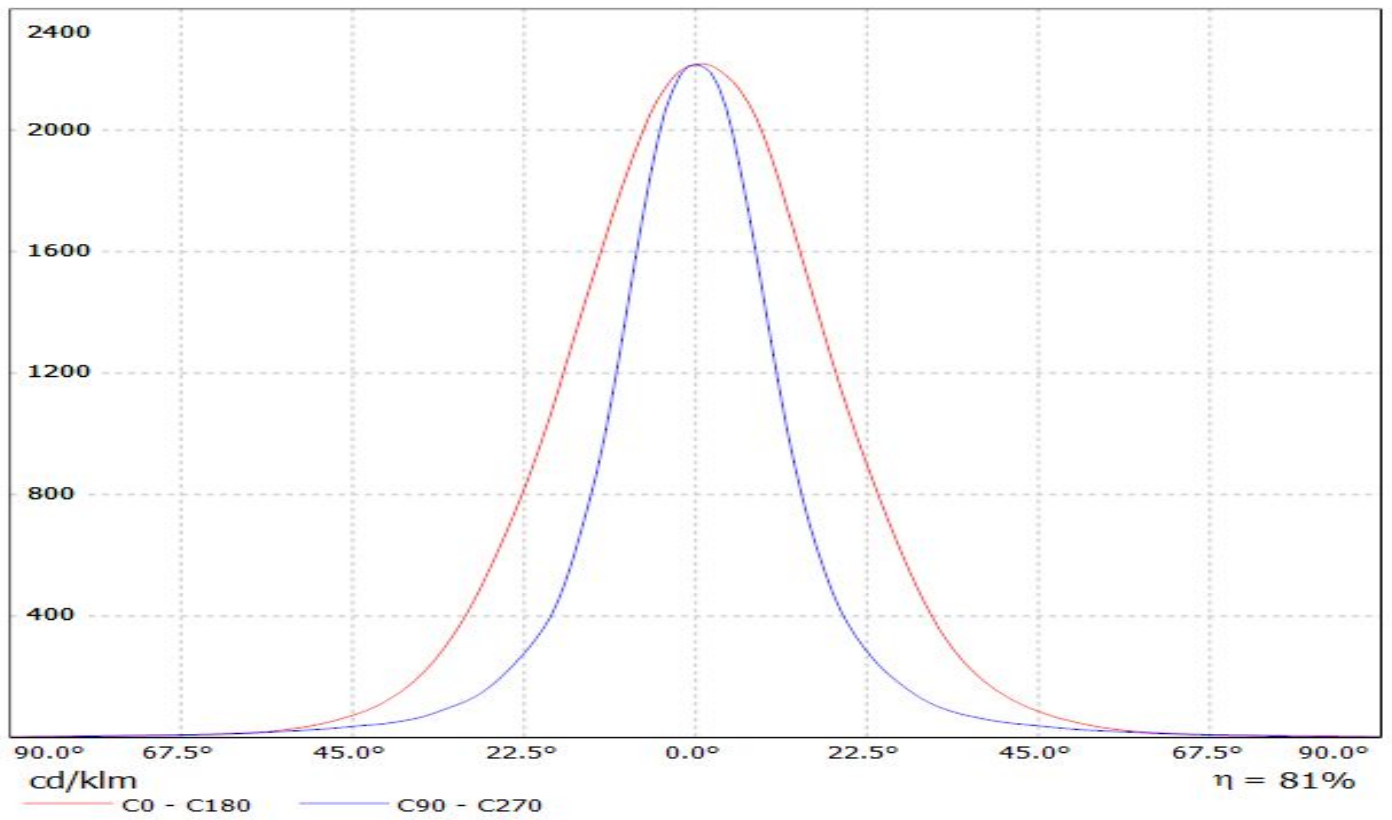

Luminaire: LEDiL Oy LARISA-O_Luxeon_A_(CLIP8&CLIP16) Eff.81.2%
Lamps: 1 x Luxeon A (66.8723lm@250mA)

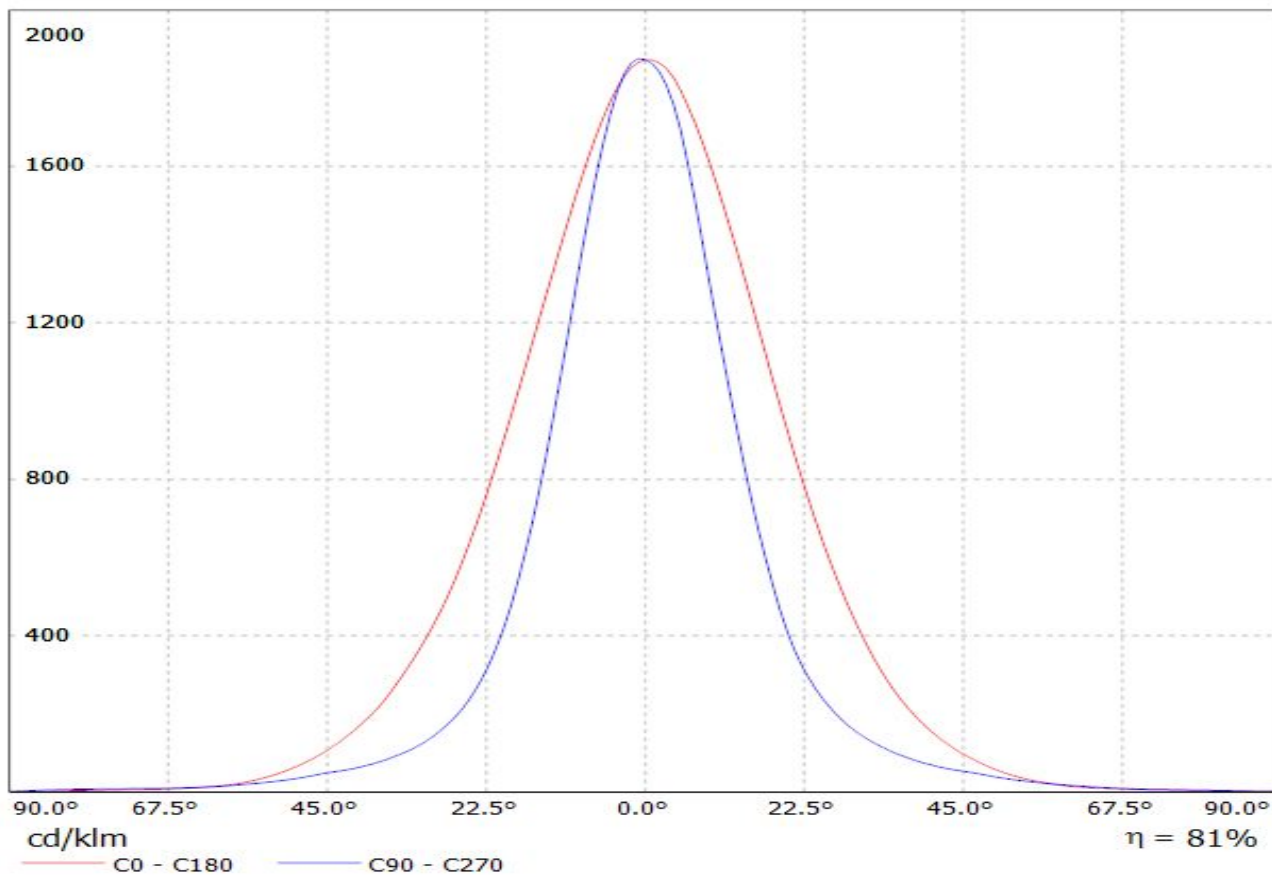

Luminaire: LEDiL Oy LARISA-O_Rebel-ES_(CLIP8&CLIP16) Eff.82.2%
Lamps: 1 x Rebel ES (89.842lm@250mA)

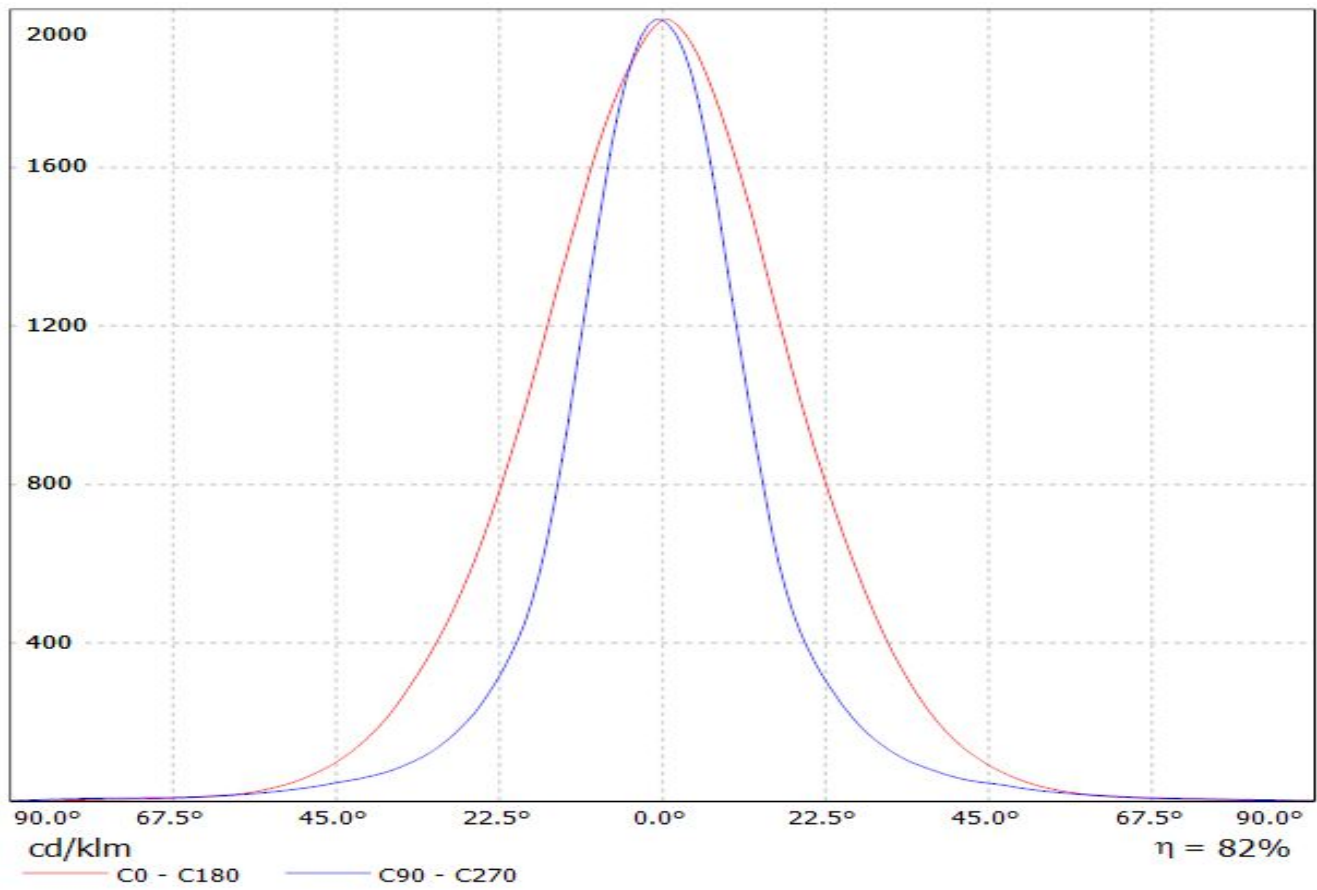

Luminaire: LEDiL Oy LARISA-O_Rebel_(CLIP8&CLIP16) Eff.84.4%
Lamps: 1 x Rebel (80.8775lm@250mA)

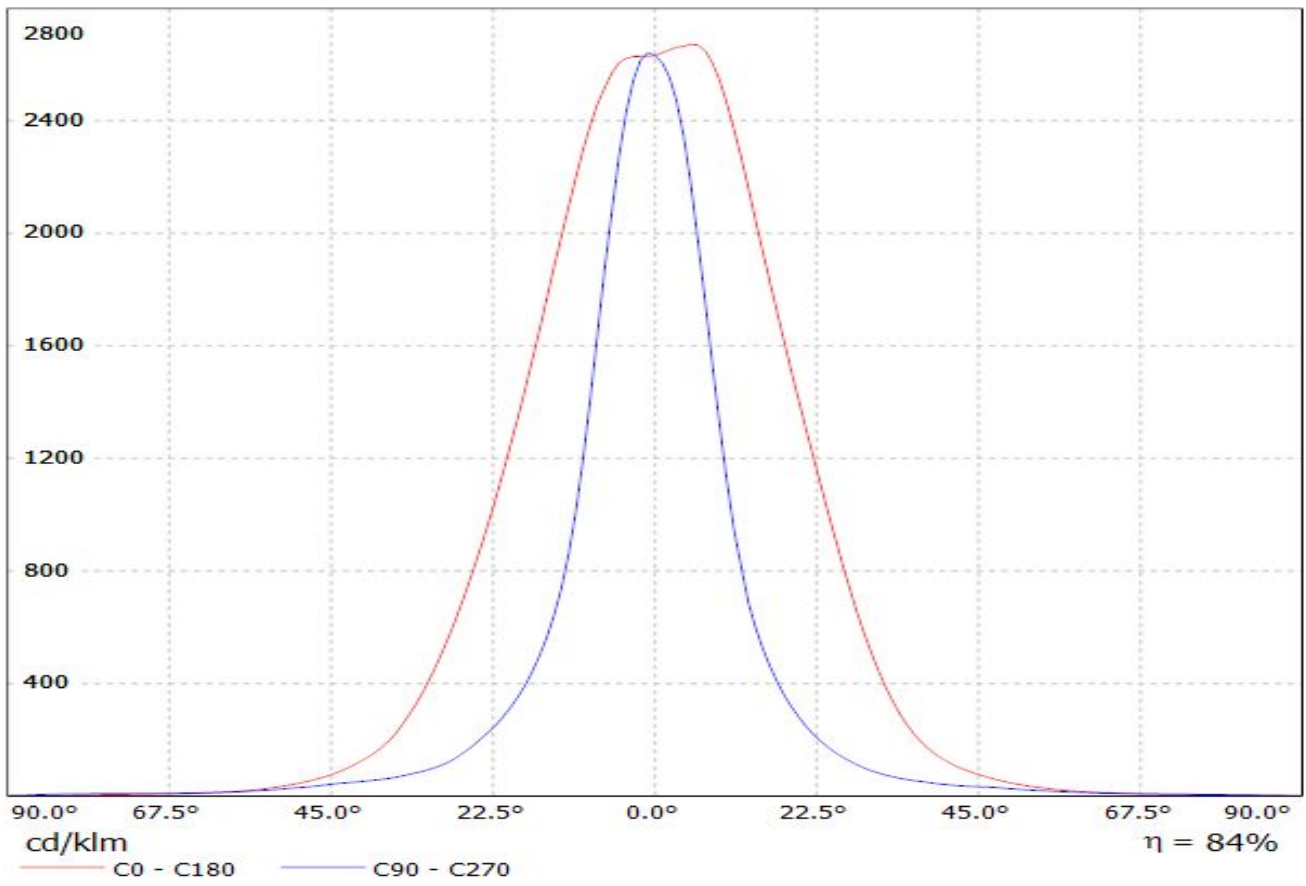

Luminaire: LEDiL Oy CP12942_LARISA-O-CLIP8_(Luxeon_Z_ES)
Lamps: 1 x Luxeon_Z_ES_50.5496lm@250mA_P=0.735456W_I=250mA

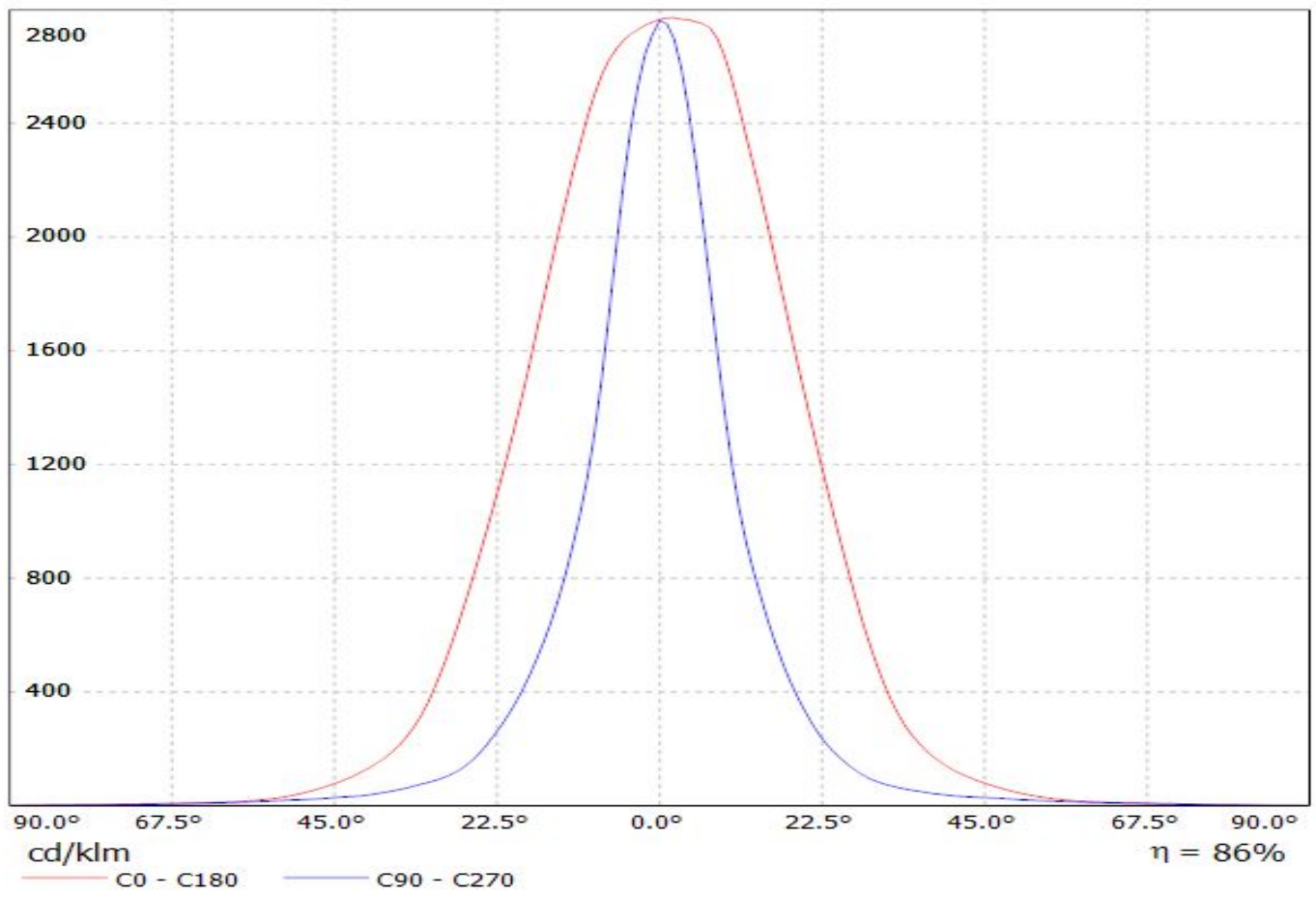

Luminaire: LEDiL Oy CP12942_LARISA-O-CLIP8_(Luxeon_Rebel_Plus)

Lamps: 1 x Philips_Lumileds_Luxeon_Rebel_Plus_(LX18-P130-3)_71.4609lm@250lm_P=0.74935W_I=0.2499A

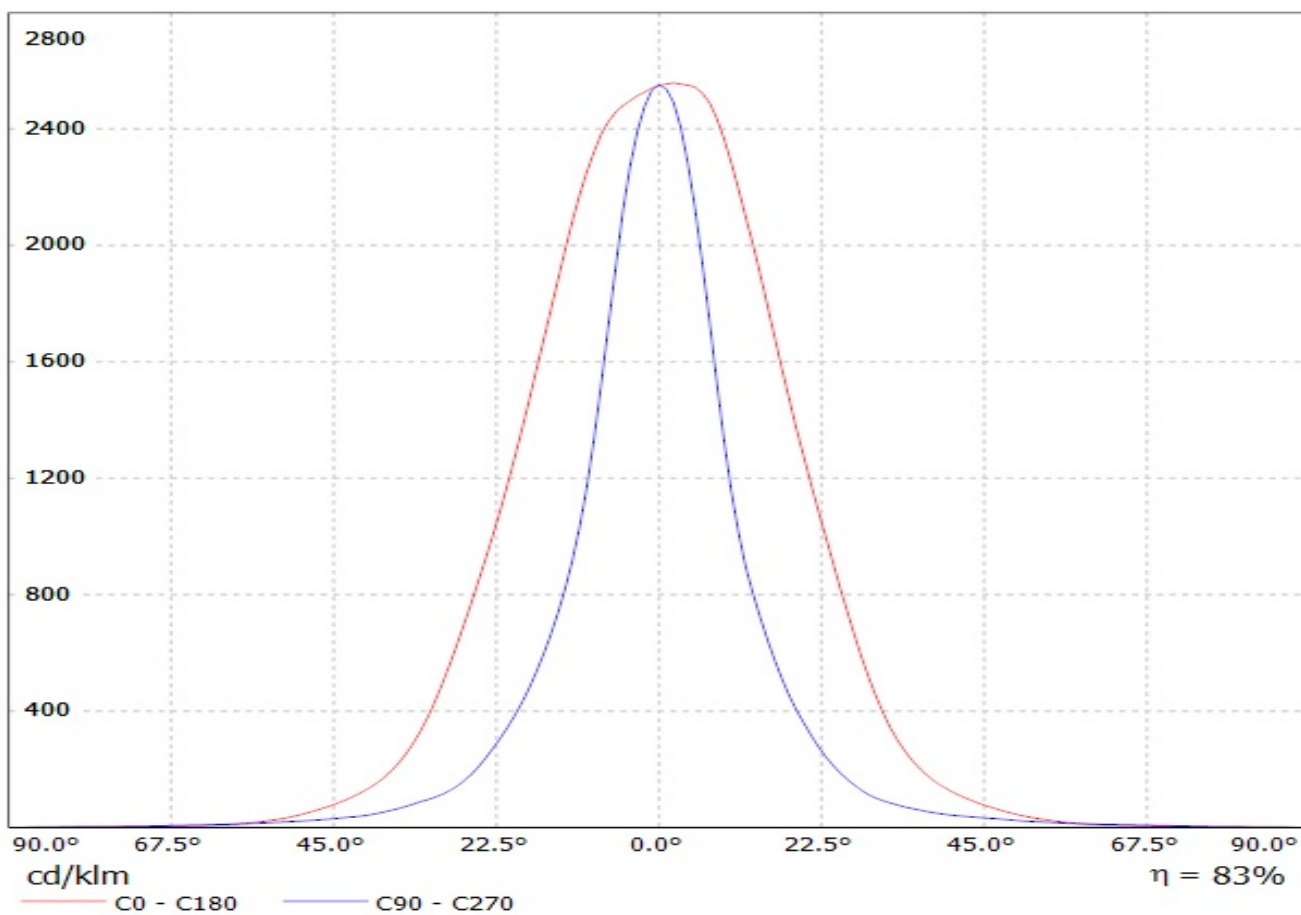

Luminaire: LEDiL Oy LARISA-O_NCS19_(CLIP8&CLIP16) Eff.80.7%
Lamps: 1 x NCS19 (88.2595lm@250mA)

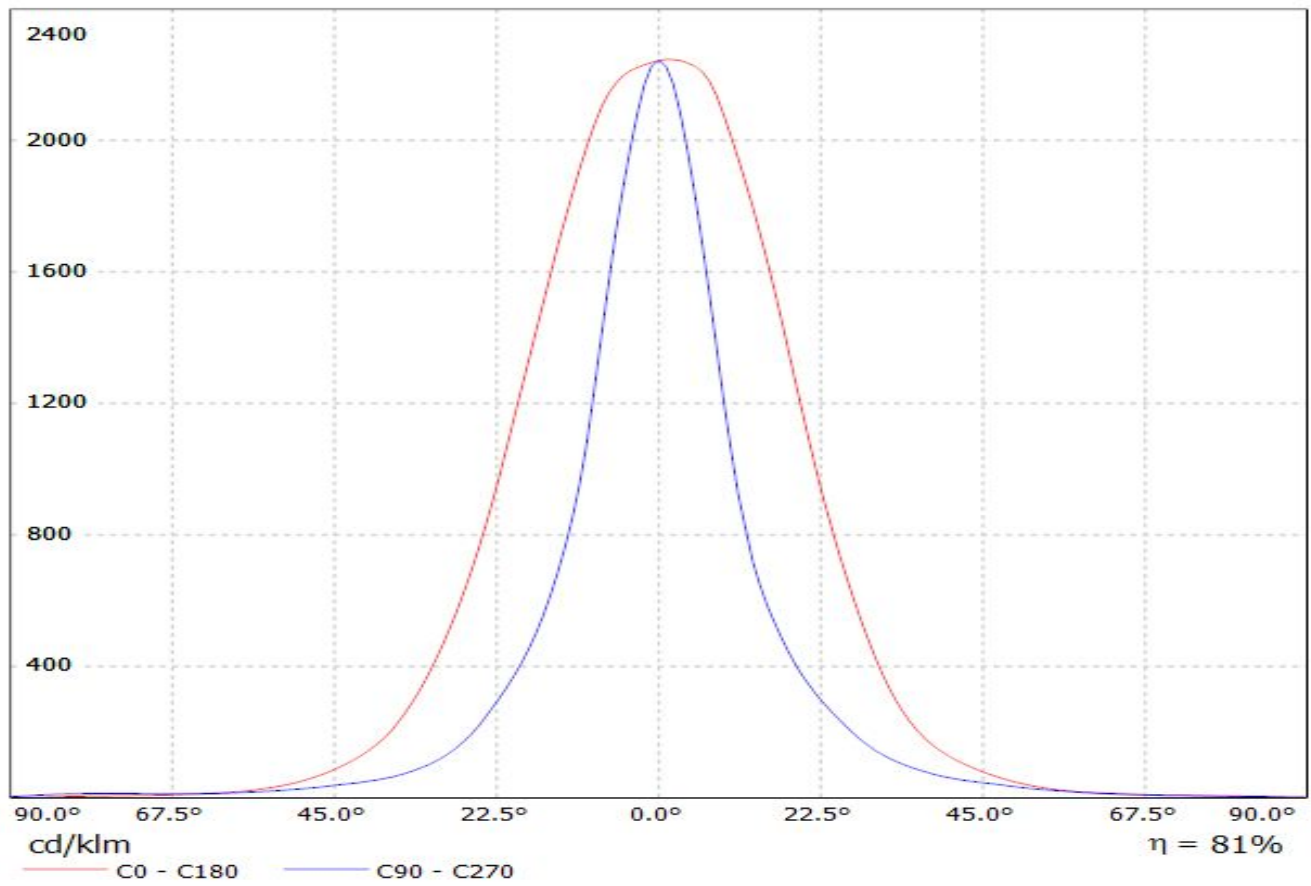

Luminaire: LEDiL Oy LARISA-O_NV519_(CLIP8&CLIP16) Eff.79.2%
Lamps: 1 x NV519 (97.9644lm@250mA)

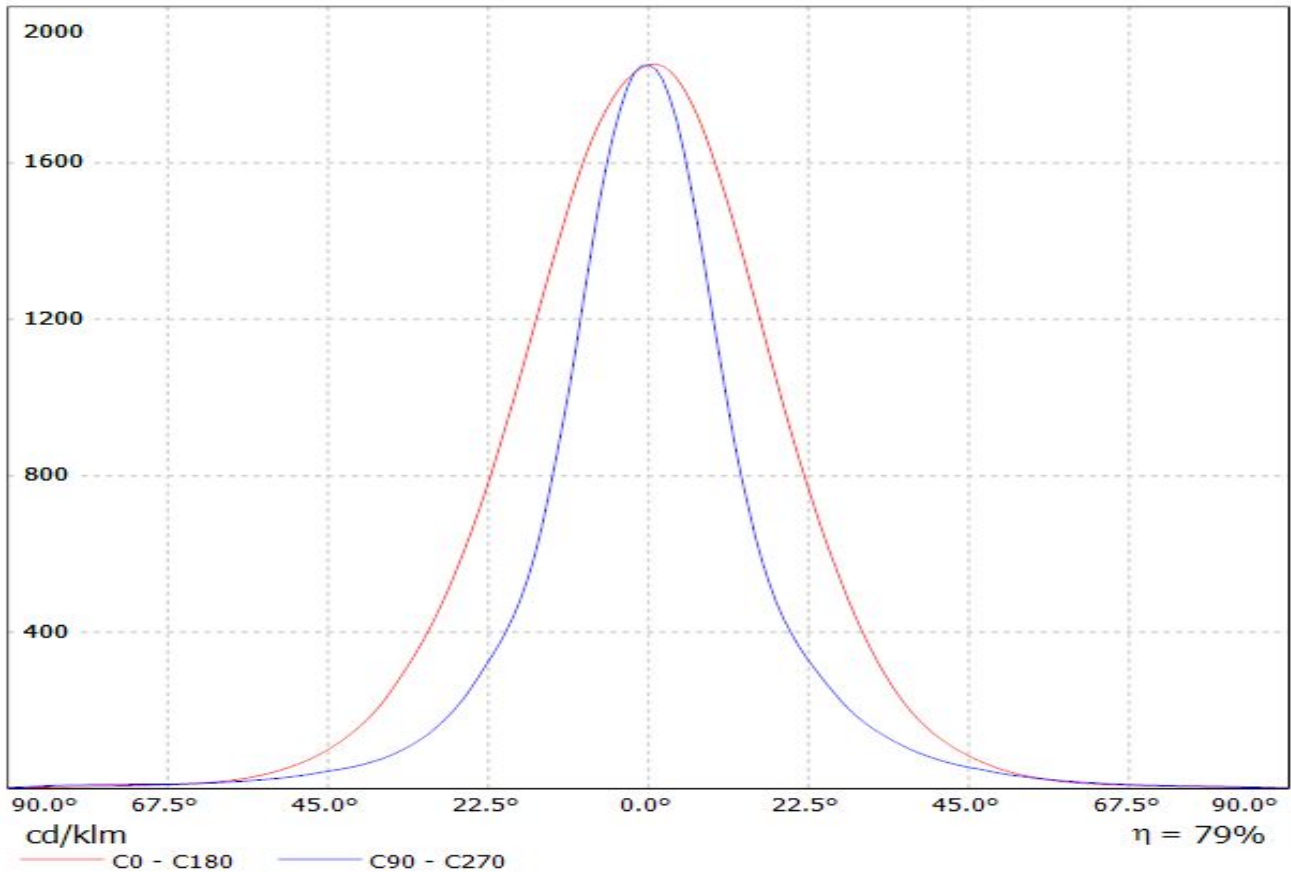

Luminaire: LEDiL Oy LARISA-O_SQ-EC_(CLIP8&CLIP16) Eff.77.3%
Lamps: 1 x SQ-EC (64.5379lm@250mA)

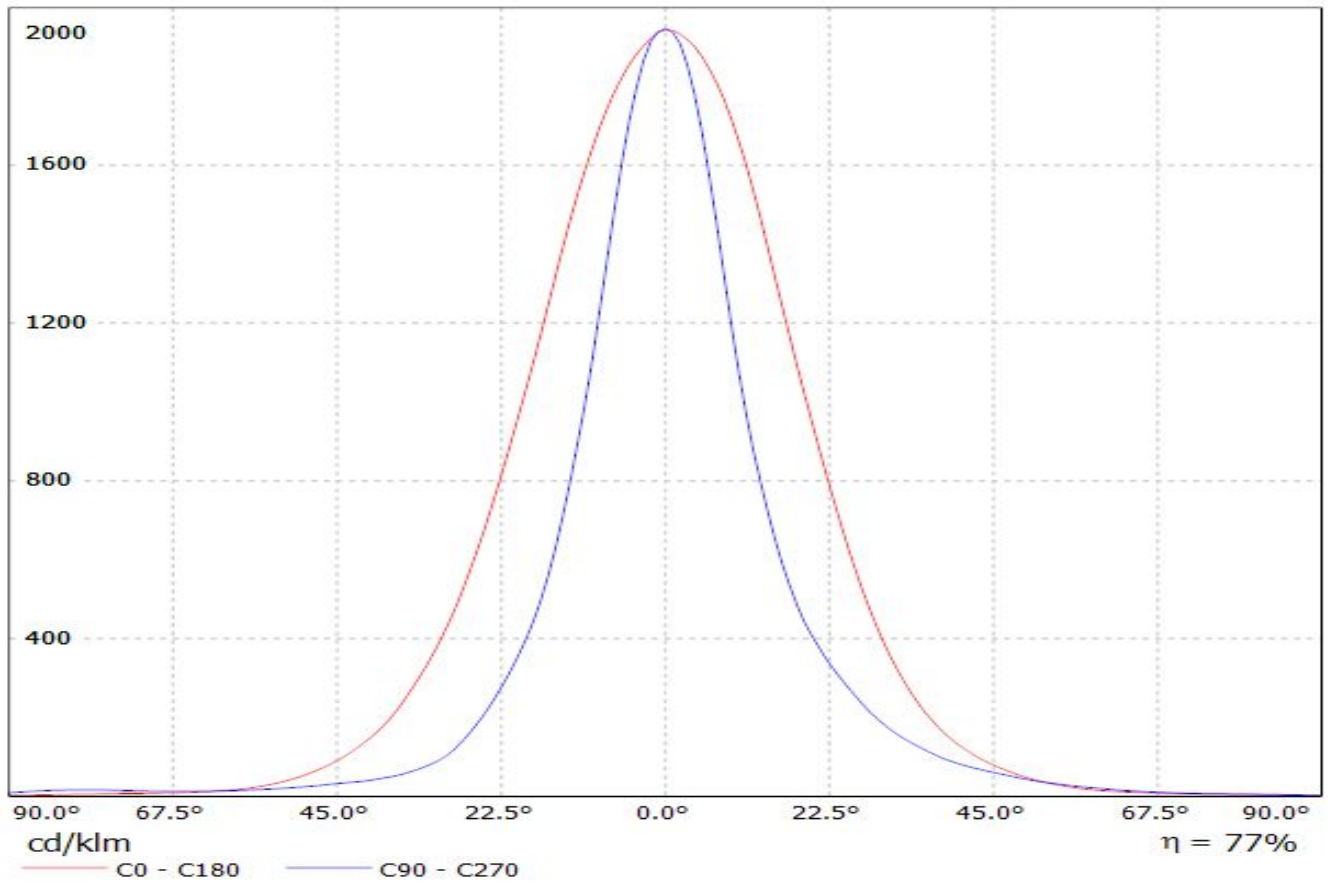

Luminaire: LEDiL Oy LARISA-O_SSL150_(CLIP8&CLIP16) Eff.84.0%
Lamps: 1 x SSL150 (71.2649lm@250mA)

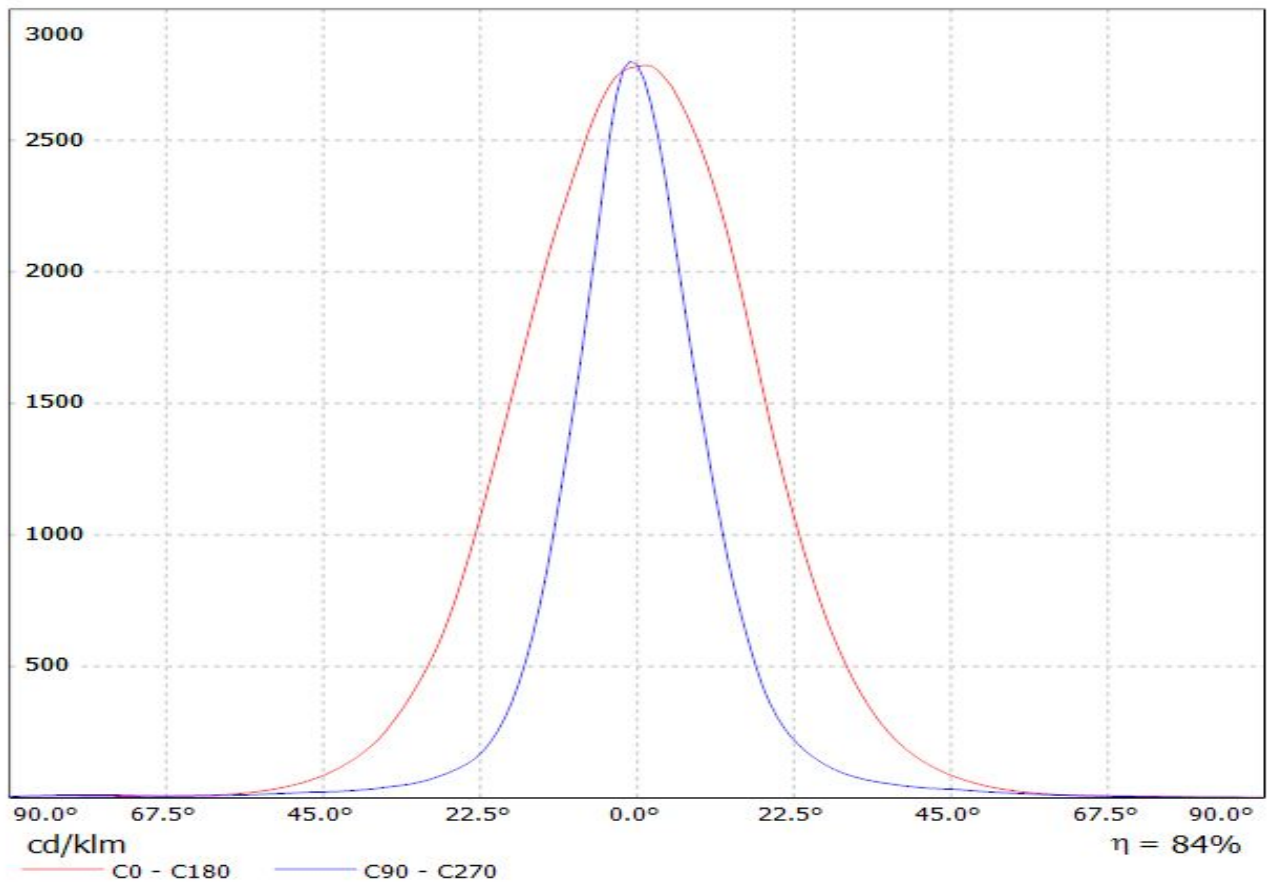

Luminaire: LEDil Oy CP12942_LARISA-O-CLIP8_(DURIS_S5) Efficiency=79%
Lamps: 1 x Osram Duris S5 (GW PSLPS1.EC) 102lm @ 150mA CCT=6300K P=1.0W I=150mA

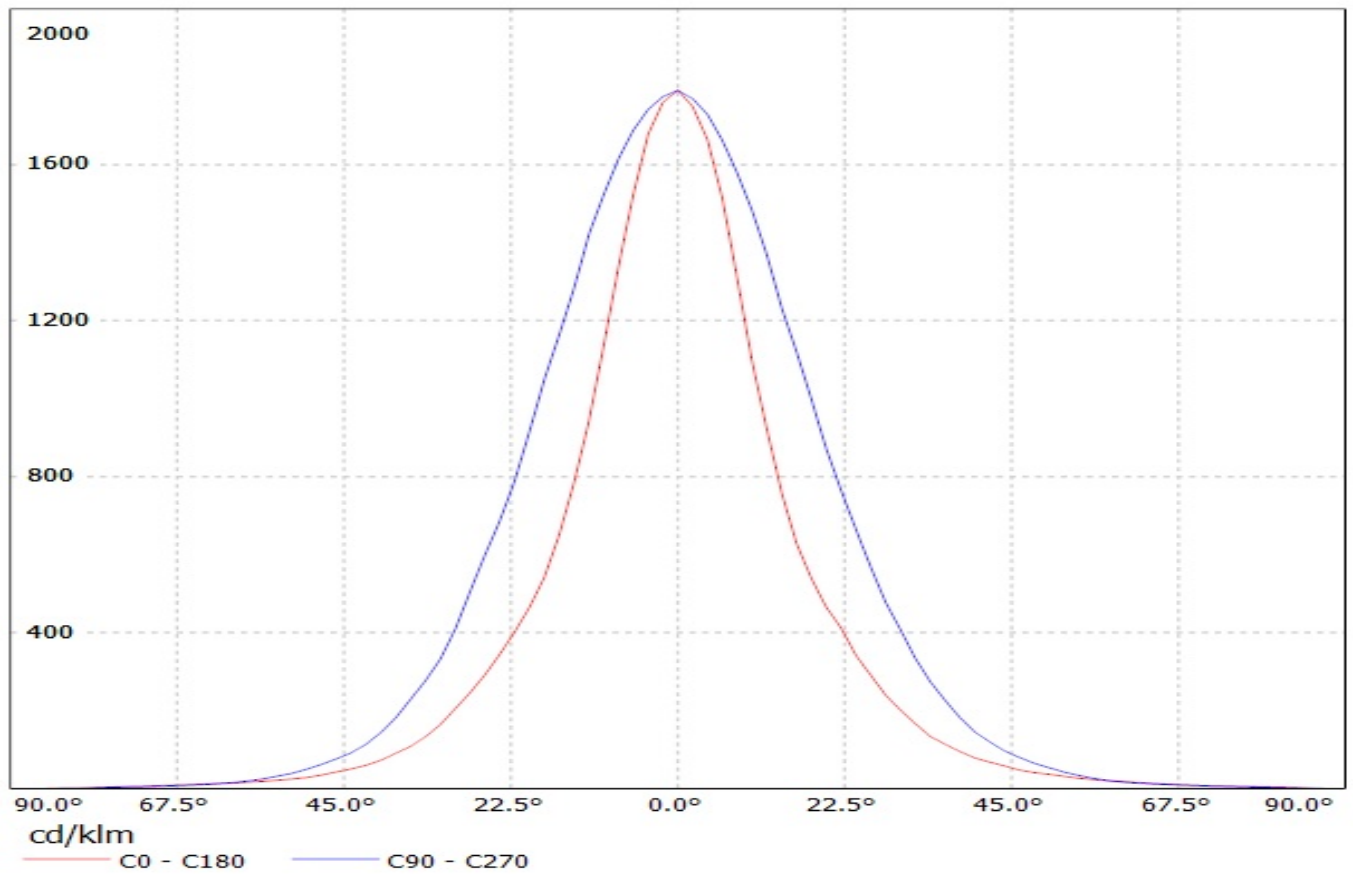

Luminaire: LEDiL Oy LARISA-O_XB-D_(CLIP8&CLIP16) Eff.79.8%
Lamps: 1 x XB-D (91.7428lm@250mA)

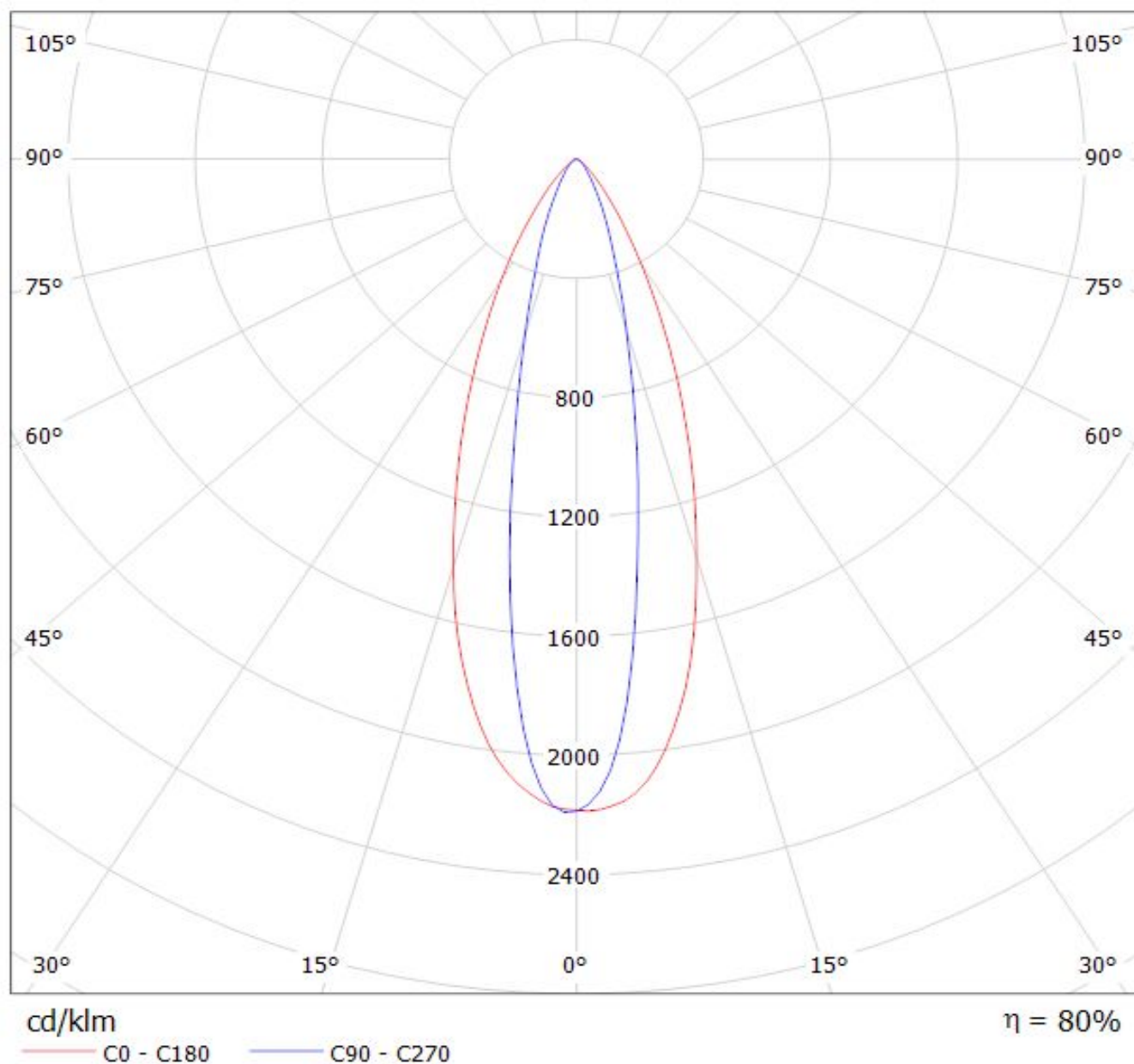

Luminaire: LEDiL Oy LARISA-O_XP-G_(CLIP8&CLIP16) Eff.82.9%
Lamps: 1 x XP-G (62.2075lm@250mA)

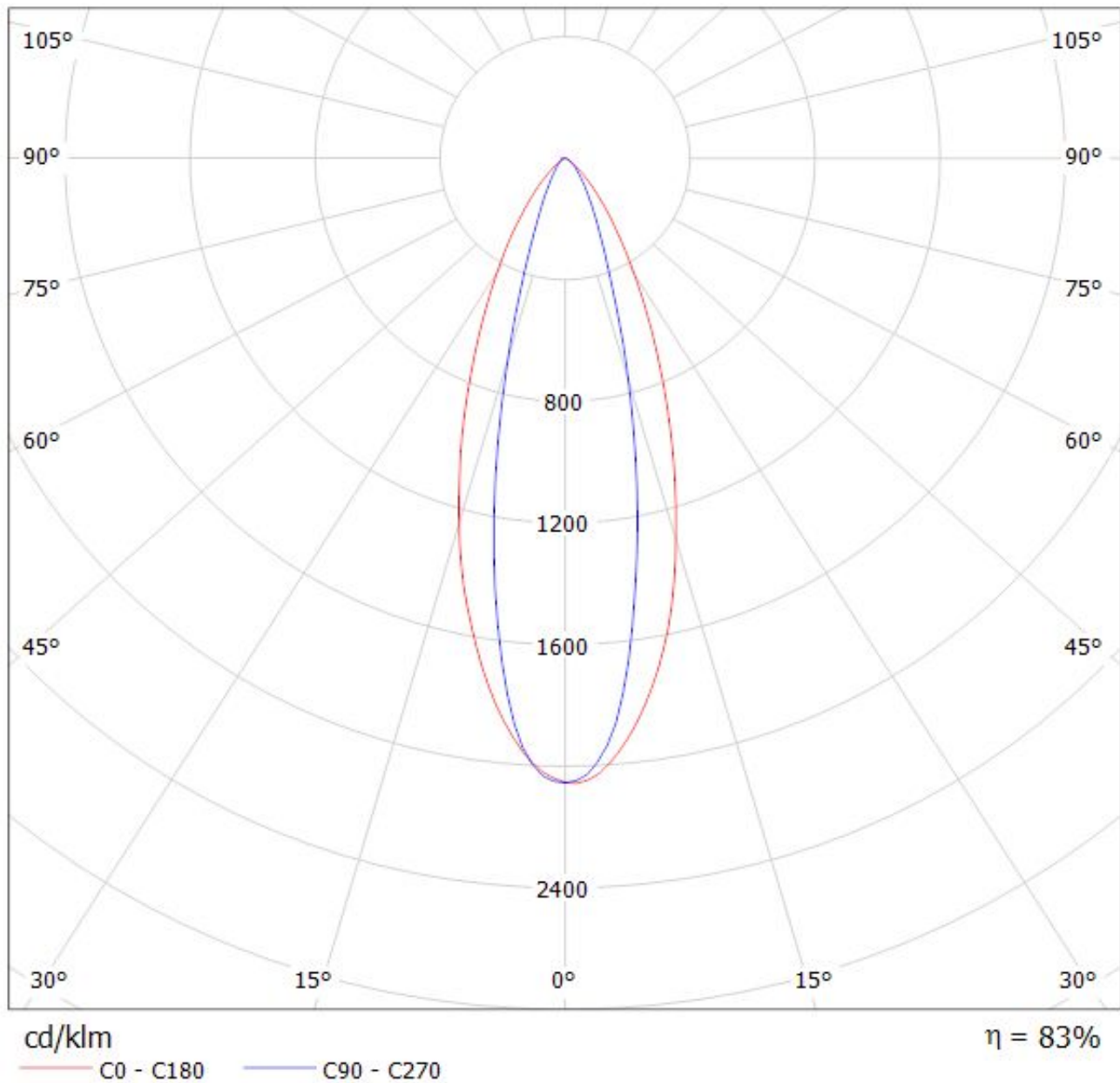

Luminaire: LEDiL Oy CP12942_LARISA-O-CLIP8_(XQ-E)

Lamps: 1 x Cree XQ-E_(XQEAWT-0-7B1-Q40-0H-00001)_81.8467lm@250mA_P=0.765444W_I=250mA

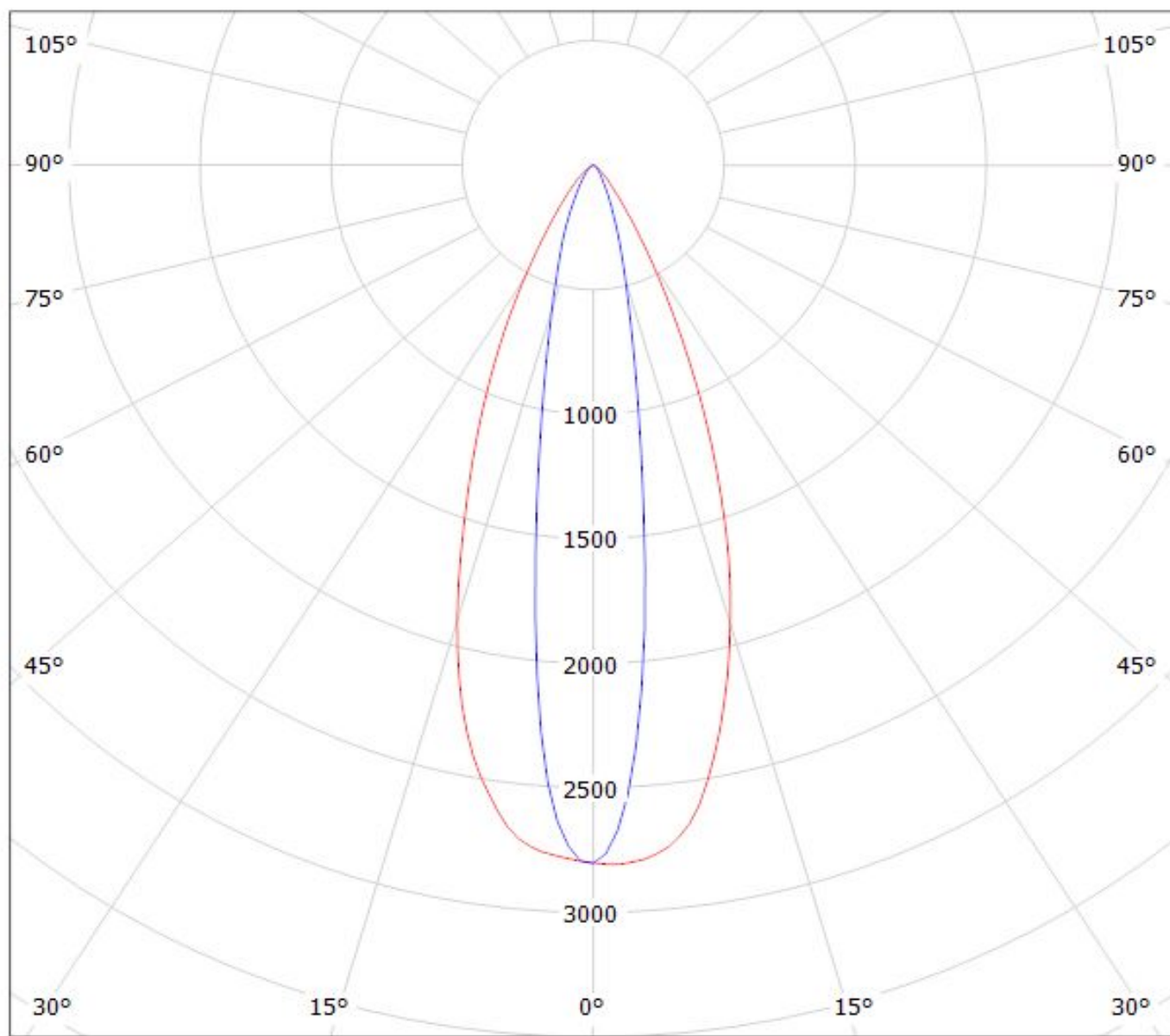

cd/klm

— C0 - C180

— C90 - C270

$\eta = 82\%$

LEDiL Oy CP12942_LARISA-O-CLIP8_(3535_Ceramic) Eff.80.6% / LDC (Polar)

Luminaire: LEDiL Oy CP12942_LARISA-O-CLIP8_(3535_Ceramic) Eff.80.6%

Lamps: 1 x LG 3535 Ceramic (95lm@250mA)

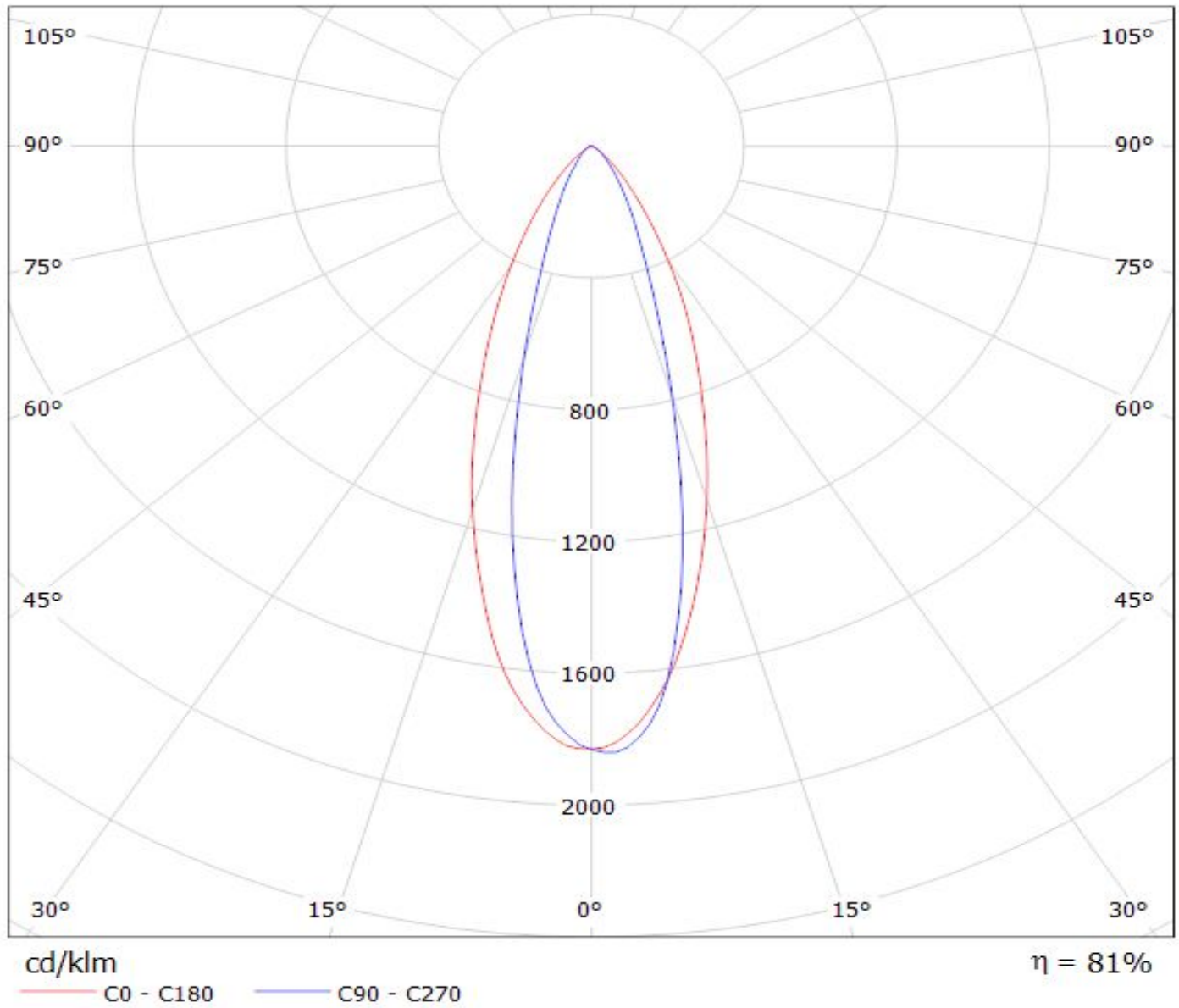

LEDiL Oy CP12942_LARISA-O-CLIP8/CP12943_LARISA-O-CLIP16_
(LG3535_2W) Eff.81.5% / LDC (Polar)

Luminaire: LEDiL Oy CP12942_LARISA-O-CLIP8/CP12943_LARISA-O-CLIP16_(LG3535_2W) Eff.81.5%
Lamps: 1 x LG3535_2W (97.3629lm@250mA)

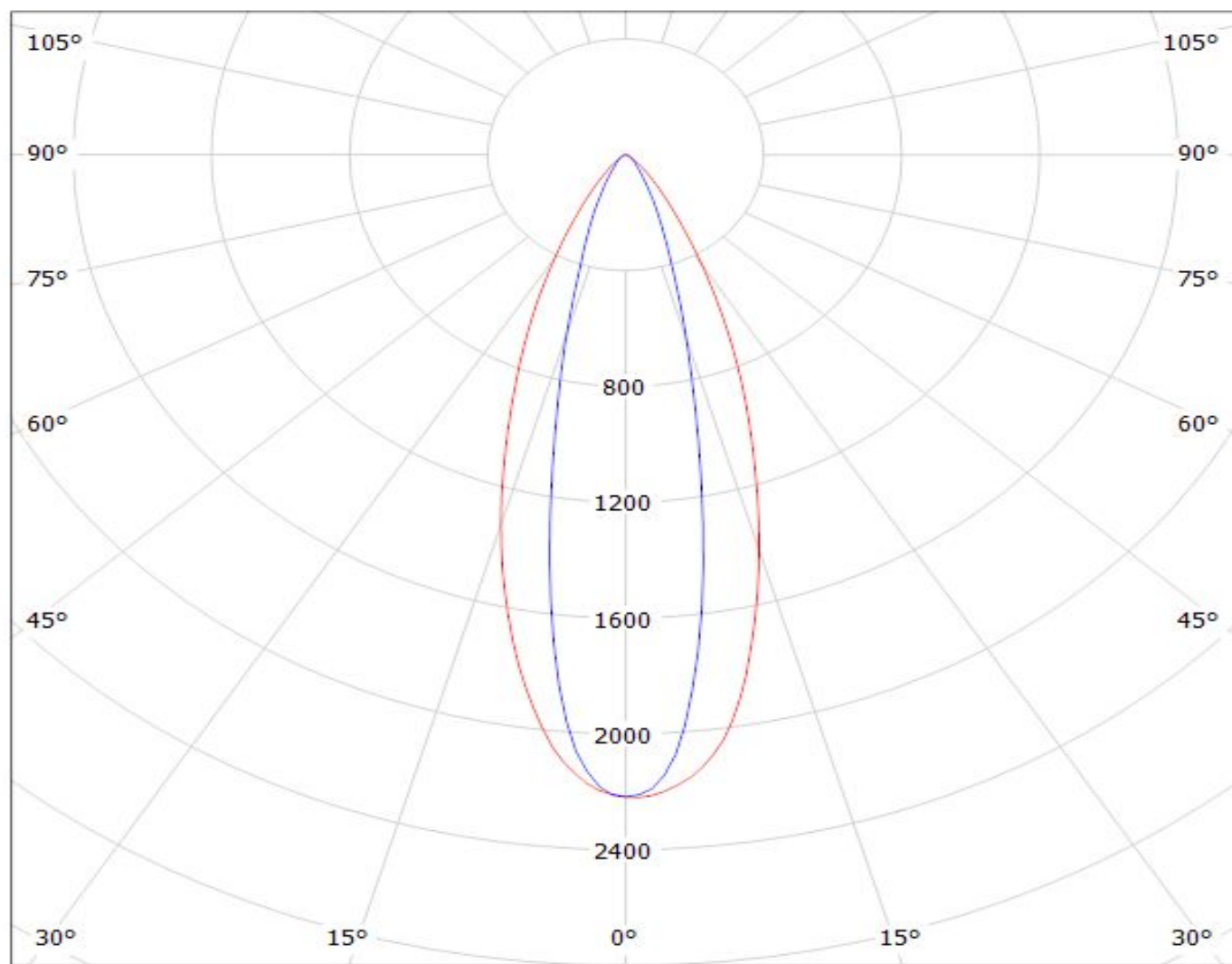

cd/klm

— C0 - C180 — C90 - C270

$\eta = 81\%$

Luminaire: LEDiL Oy LARISA-O_Luxeon_A_(CLIP8&CLIP16) Eff.81.2%
Lamps: 1 x Luxeon A (66.8723lm@250mA)

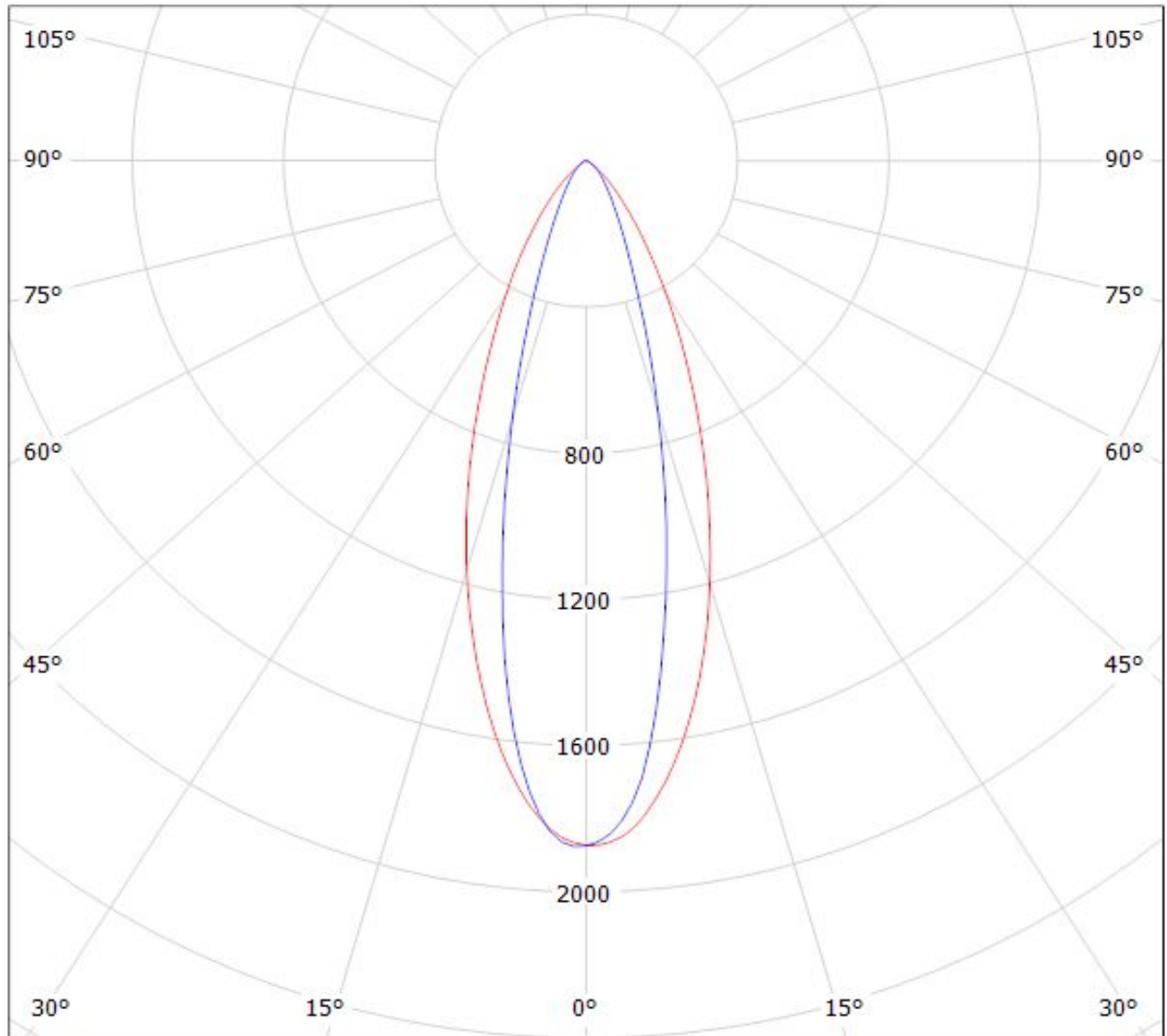

cd/klm
— C0 - C180 — C90 - C270

$\eta = 81\%$

Luminaire: LEDiL Oy LARISA-O_Rebel-ES_(CLIP8&CLIP16) Eff.82.2%
Lamps: 1 x Rebel ES (89.842lm@250mA)

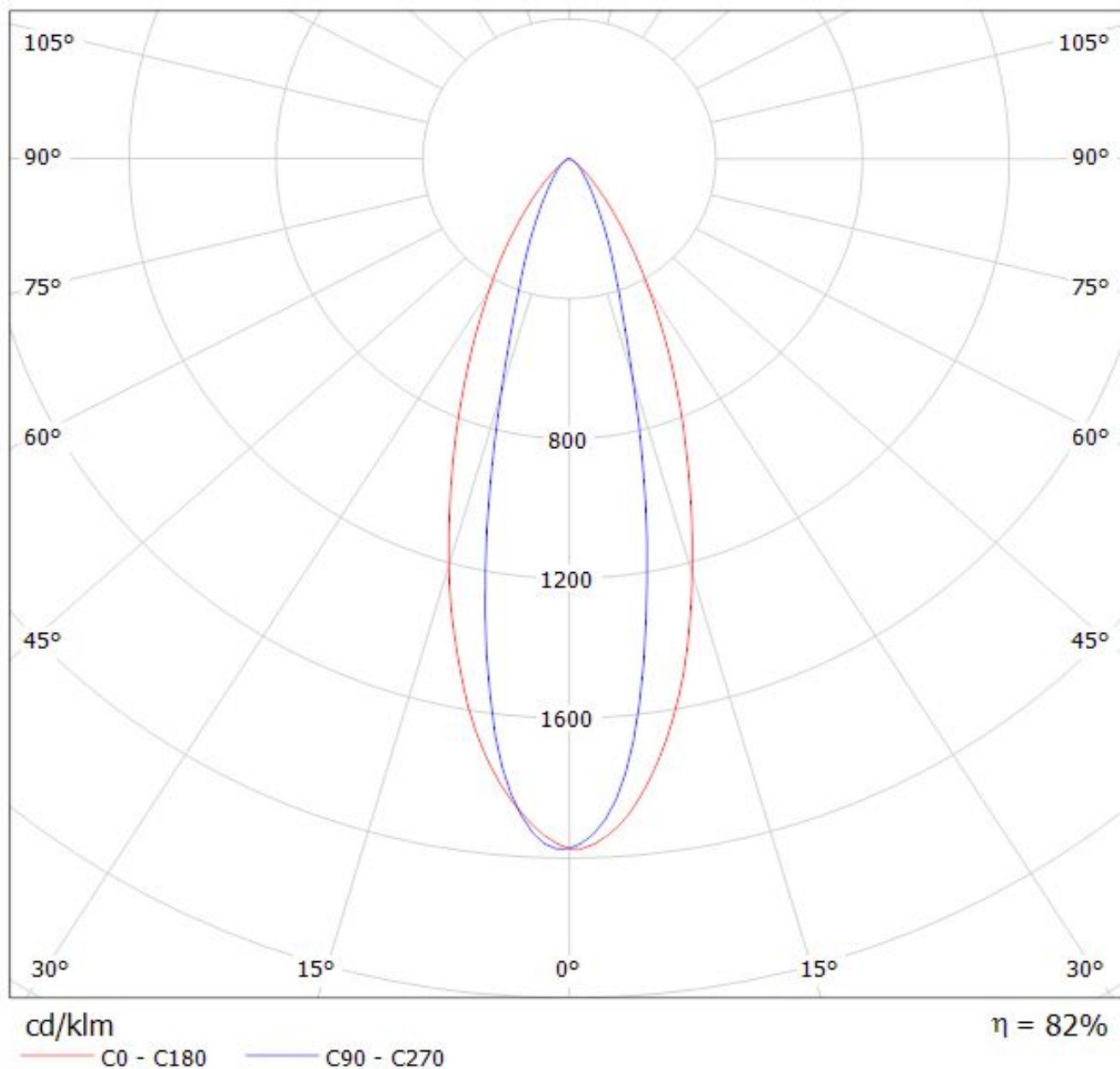

Luminaire: LEDiL Oy LARISA-O_Rebel_(CLIP8&CLIP16) Eff.84.4%
Lamps: 1 x Rebel (80.8775lm@250mA)

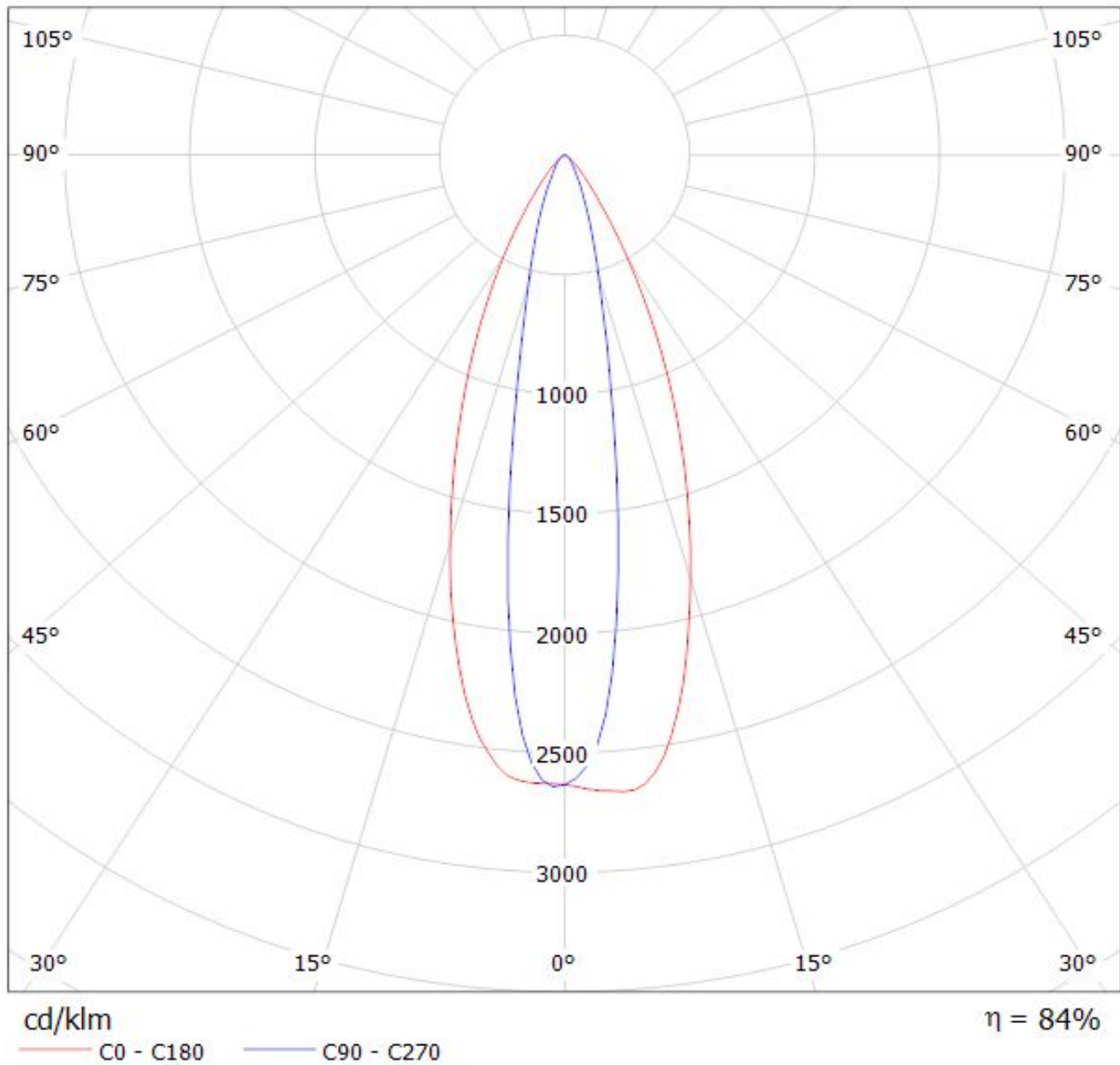

Luminaire: LEDiL Oy CP12942_LARISA-O-CLIP8_(Luxeon_Z_ES)
Lamps: 1 x Luxeon_Z_ES_50.5496lm@250mA_P=0.735456W_I=250mA

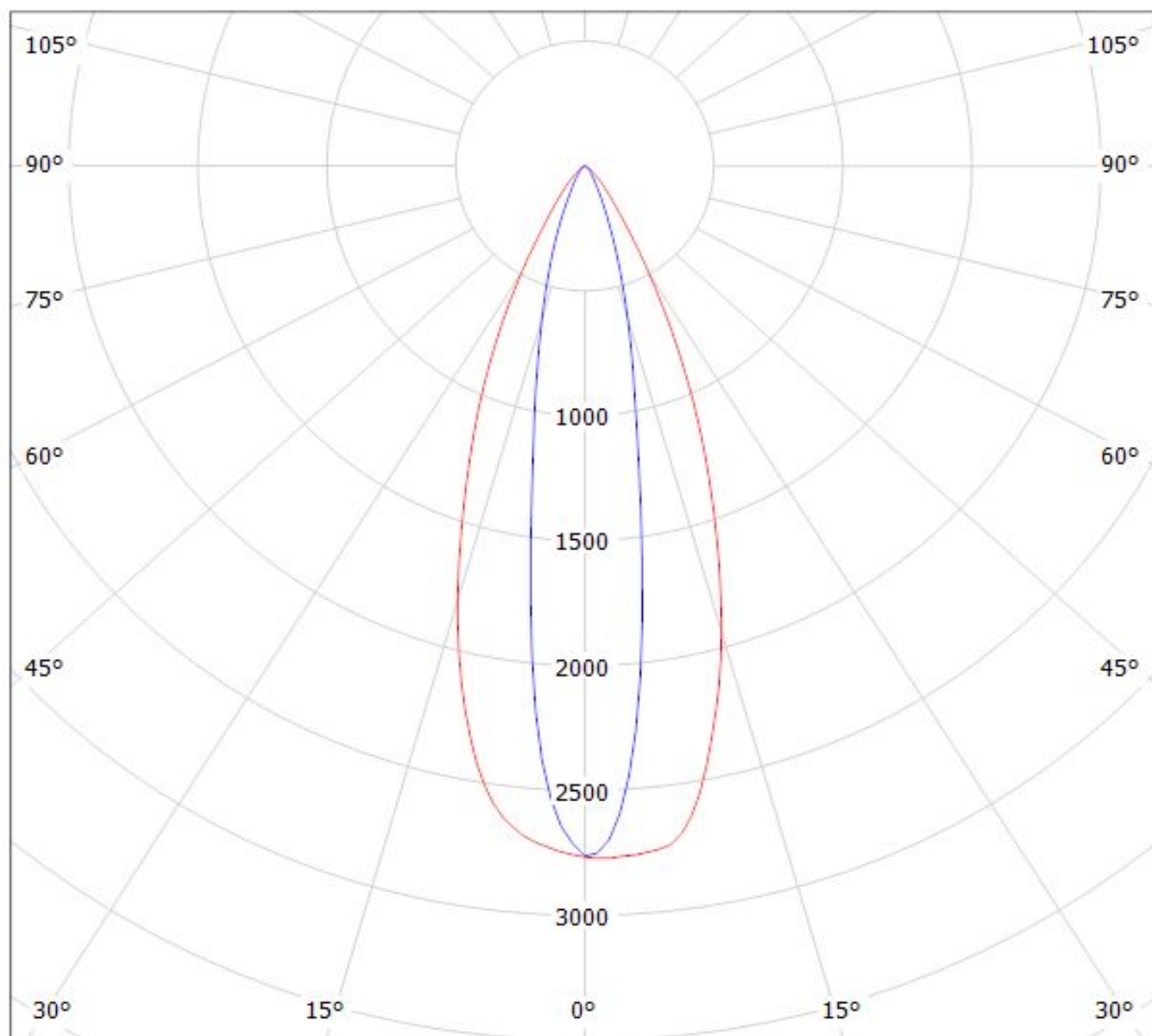

cd/klm

$\eta = 86\%$

— C0 - C180 — C90 - C270

Luminaire: LEDiL Oy CP12942_LARISA-O-CLIP8_(Luxeon_Rebel_Plus)

Lamps: 1 x Philips_Lumileds_Luxeon_Rebel_Plus_(LX18-P130-3)_71.4609lm@250lm_P=0.74935W_I=0.2499A

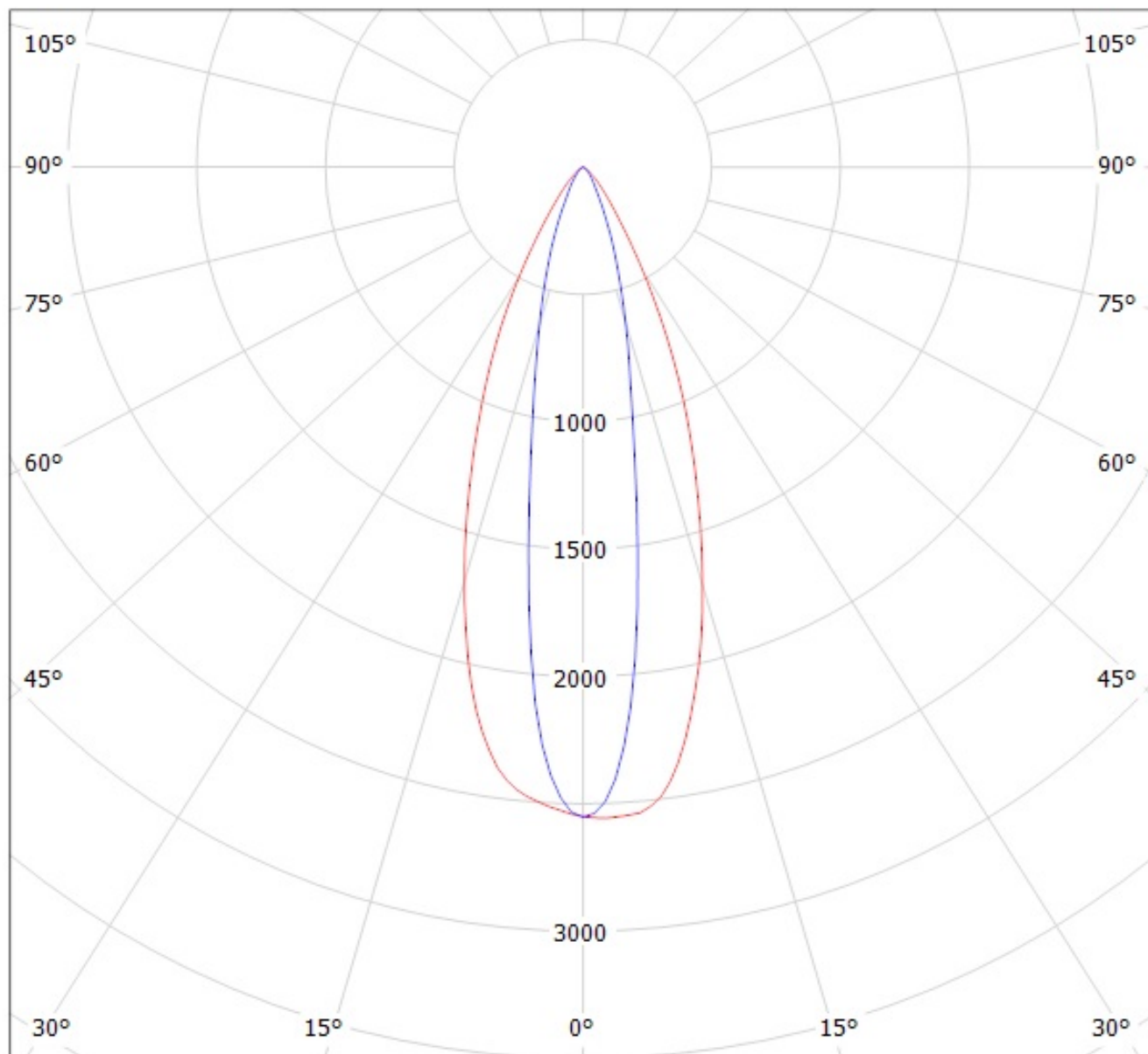

cd/klm

— C0 - C180 — C90 - C270

$\eta = 83\%$

Luminaire: LEDiL Oy LARISA-O_NCS19_(CLIP8&CLIP16) Eff.80.7%
Lamps: 1 x NCS19 (88.2595lm@250mA)

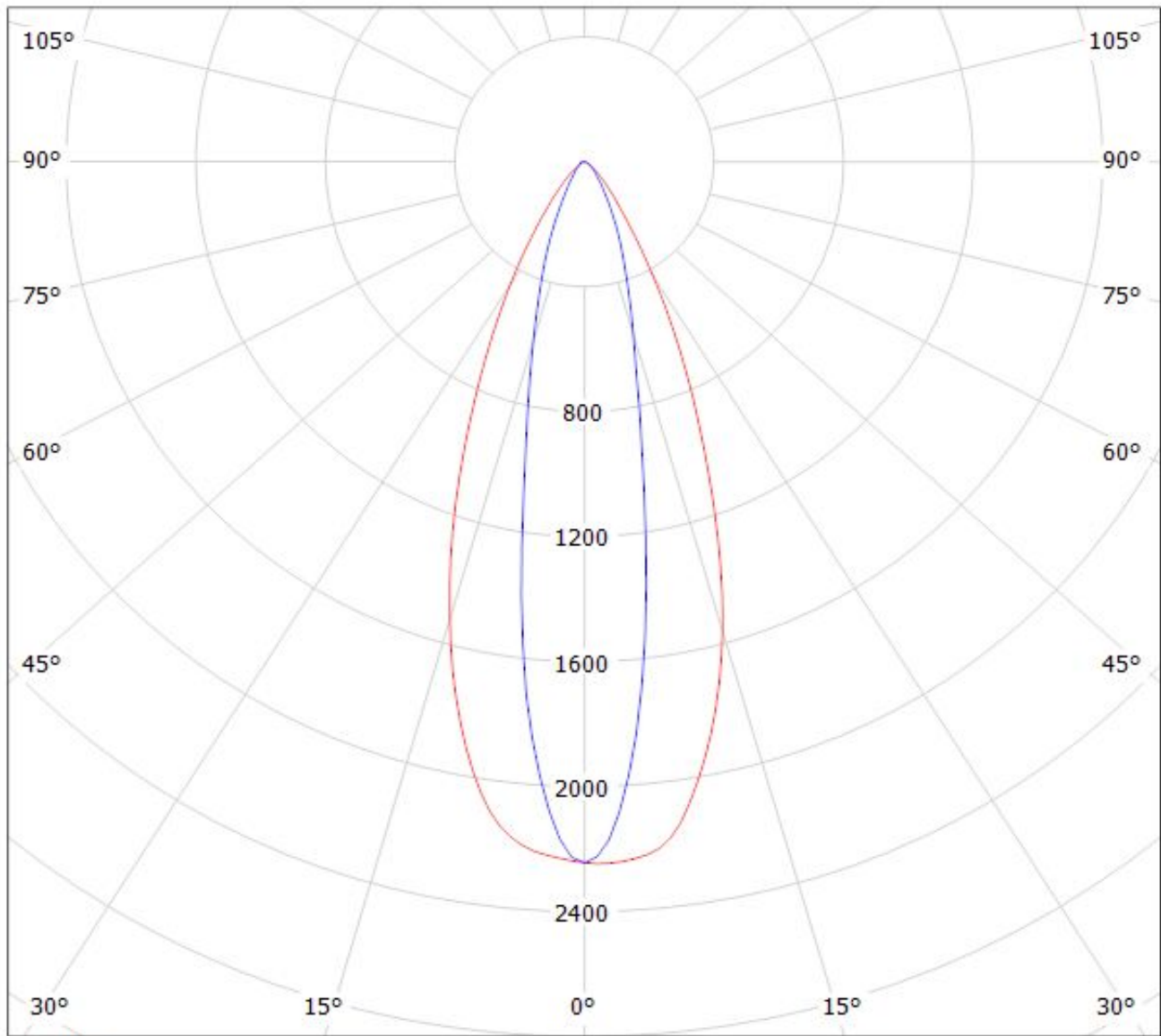

cd/klm

— C0 - C180 — C90 - C270

$\eta = 81\%$

Luminaire: LEDiL Oy LARISA-O_NV519_(CLIP8&CLIP16) Eff.79.2%
Lamps: 1 x NV519 (97.9644lm@250mA)

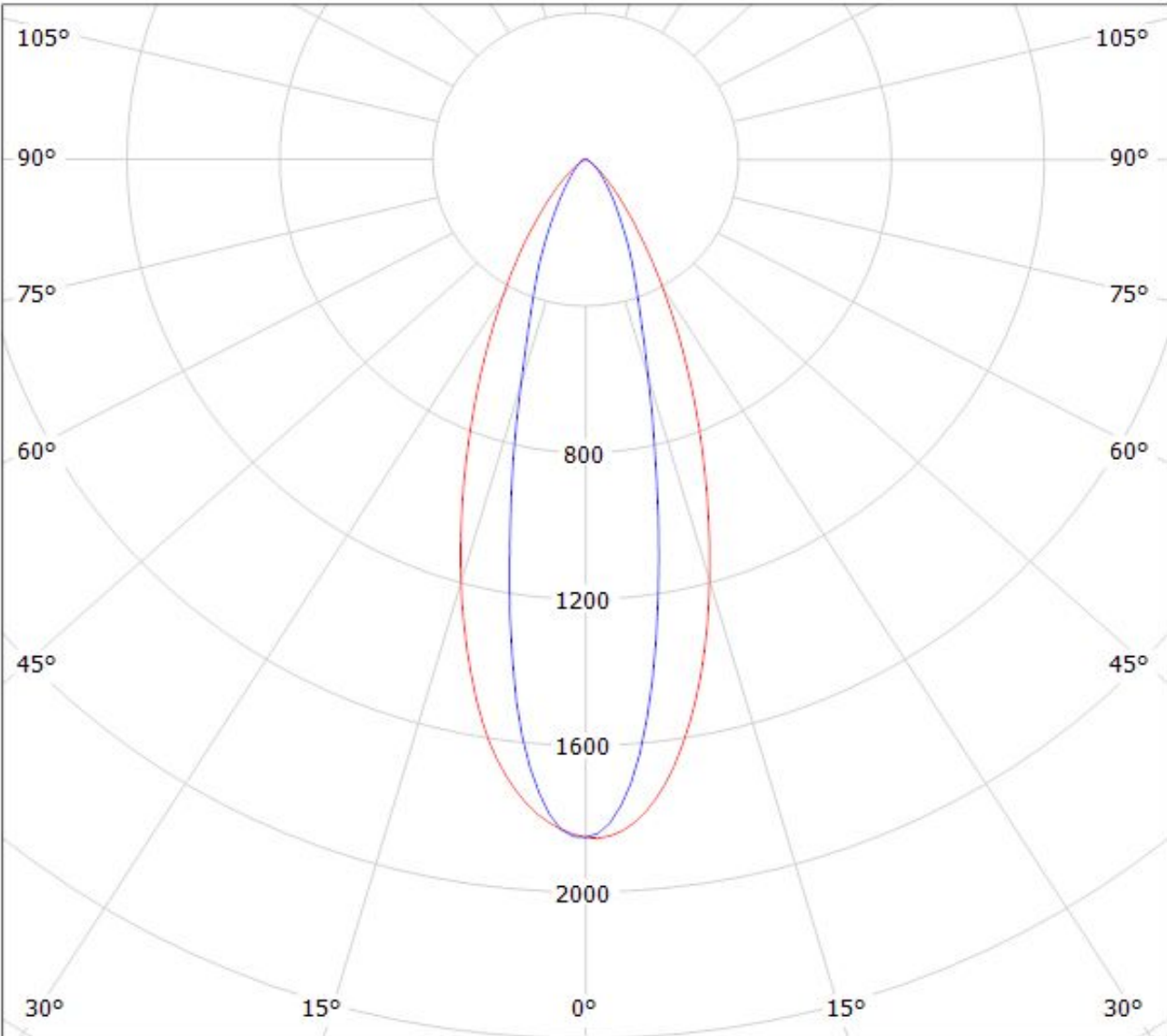

cd/klm

— C0 - C180 — C90 - C270

$\eta = 79\%$

Luminaire: LEDiL Oy LARISA-O_SQ-EC_(CLIP8&CLIP16) Eff.77.3%
Lamps: 1 x SQ-EC (64.5379lm@250mA)

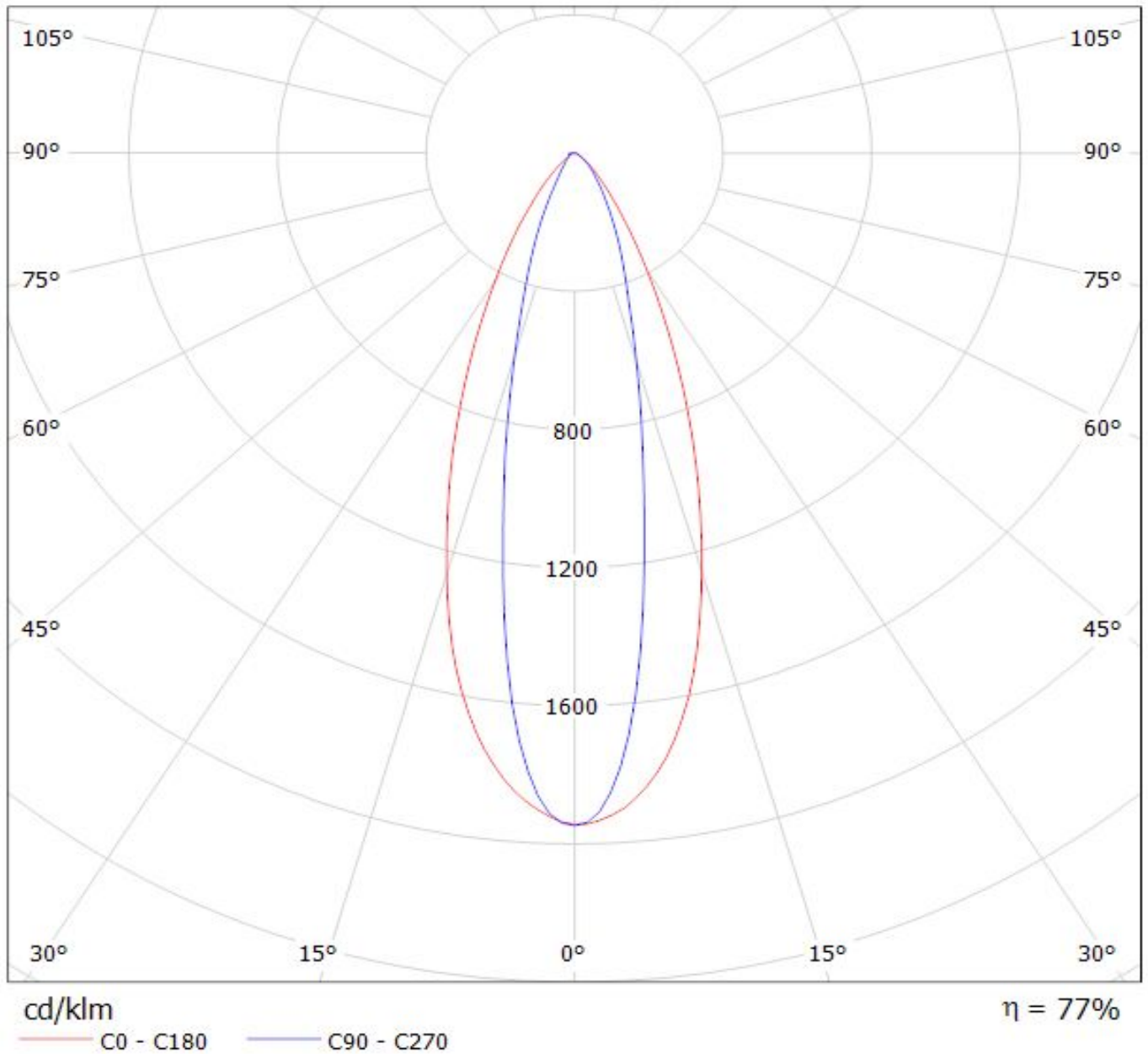

Luminaire: LEDiL Oy LARISA-O_SSL150_(CLIP8&CLIP16) Eff.84.0%
Lamps: 1 x SSL150 (71.2649lm@250mA)

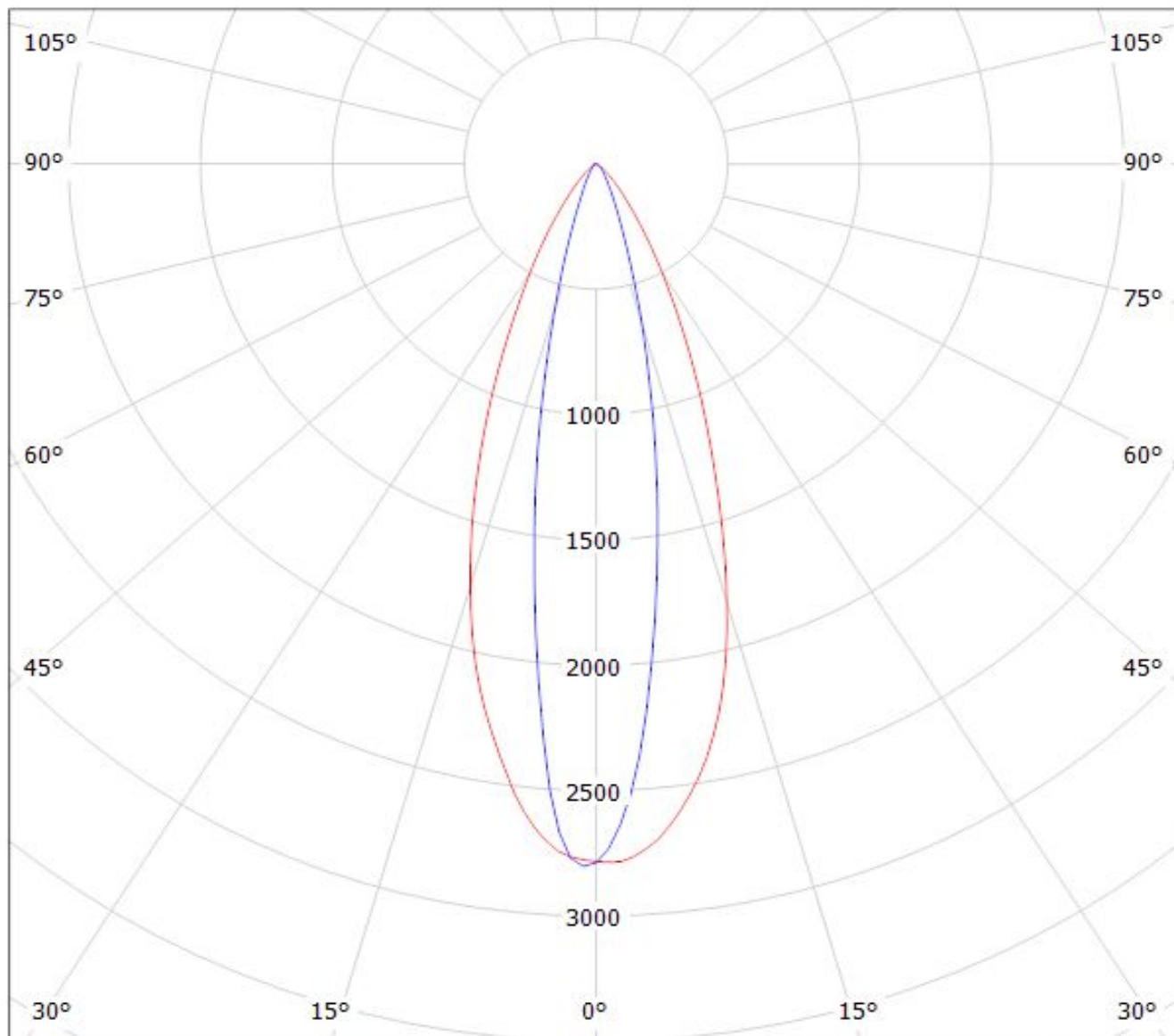

cd/klm

$\eta = 84\%$

— C0 - C180 — C90 - C270

Luminaire: LEDil Oy CP12942_LARISA-O-CLIP8_(DURIS_S5) Efficiency=79%
Lamps: 1 x Osram Duris S5 (GW PSLPS1.EC) 102lm @ 150mA CCT=6300K P=1.0W I=150mA

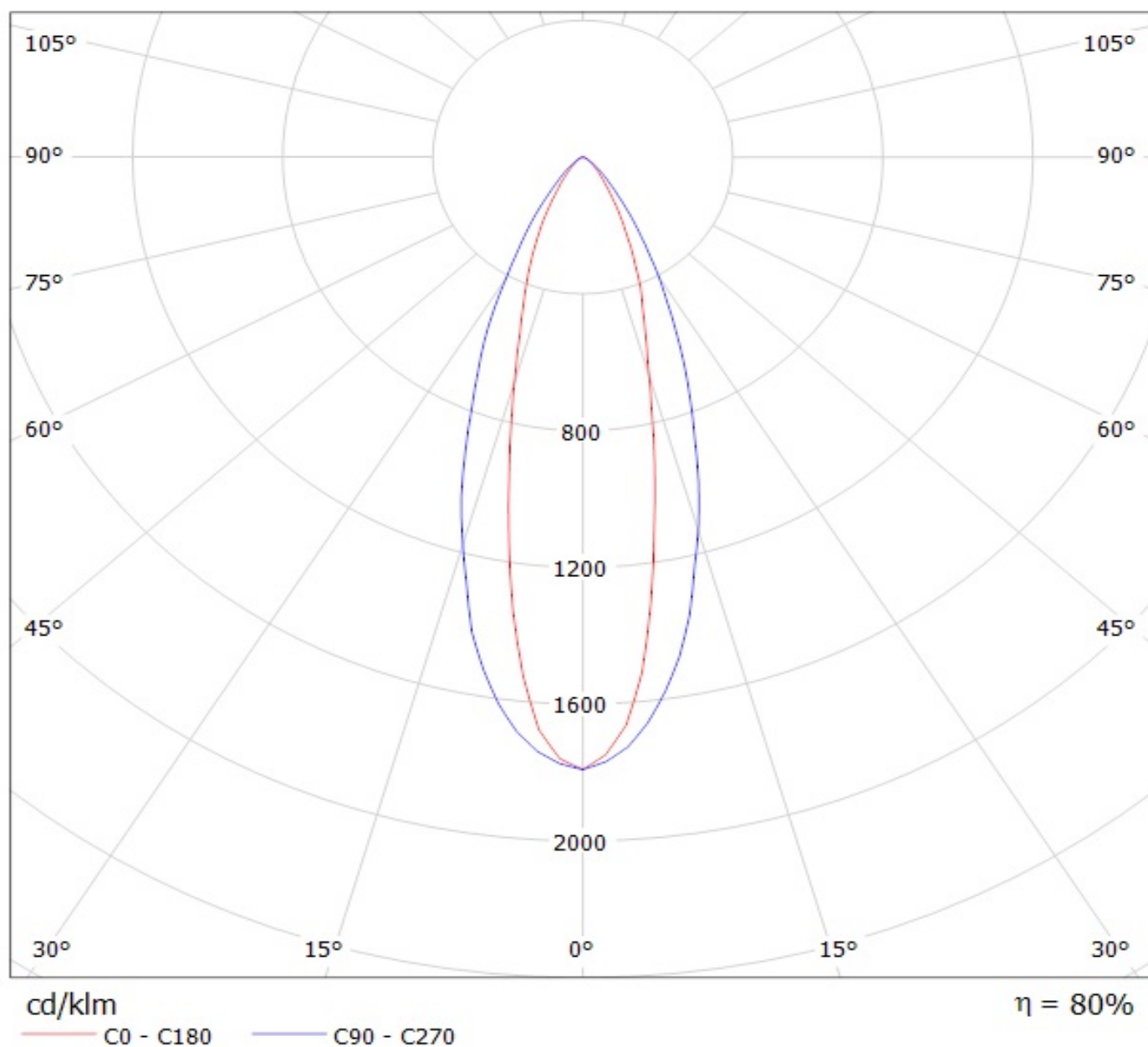

NOTE: The typical divergence will be changed by different color, chip size and chip position tolerance. The typical total divergence is the full angle measured where the luminous intensity is half of the peak value.