

Data sheet

Commercial Art.No.: 02.123.7201.0

Female contact 1,5 QMM AU

Female contact, turned Ø 2,5 mm, 1,5 mm², AWG 16, Au



Commercial Art.No.	02.123.7201.0
EAN	4015573589391
Order Unit	200

Technical data

General

Wire strip length	7 mm
Min. conductor cross section flexible wire	1.5 mm ²
Max. conductor cross section flexible wire	1.5 mm ²
Min. UL/CSA wire diameter flexible wire	16 AWG
Max. UL/CSA wire diameter flexible wire	16 AWG
Connection type	Crimp
Material	Brass
Massive contact	yes
Contact pin diameter	2.5 mm
Inflammability class of insulation material acc. with UL94	Other
Contact resistance	≤ 1.5 mOhm

Classification

ECLASS 11	
ECLASS 8.1	27440204
ETIM 7.0	EC000796
ETIM 6.0	EC000796
ETIM 5.0	EC000796
ETIM 4.0	EC000796
ETIM 3.0	EC000796

Product compliance

ROHS conformity status	Compliant/Exempted
ROHS exceptions	III-6(c)
REACH-SVHC conformity status	Duty-To-Declare
REACH-SVHC substances	Lead
REACH-SVHC CAS numbers	7439-92-1

Accessories

Commercial Art.No.:	Article-type description:	Description:
05.502.2100.0	Crimping die B	Crimp dies for revos crimping tool, usable for crimp-contacts with a cross section of 0.14-1.0 mm ² , 1.5 mm ² , 2.5 mm ² and 4.0 mm ²
95.101.0800.0	Basic crimping tool .	Crimping tool kit
05.502.3500.0	Extraction tool 500/690V-SER.	Extraction tool for turned contacts with a diameter of 2.5 mm
05.502.3300.0	Contact positioner 3	Contact positioner 3

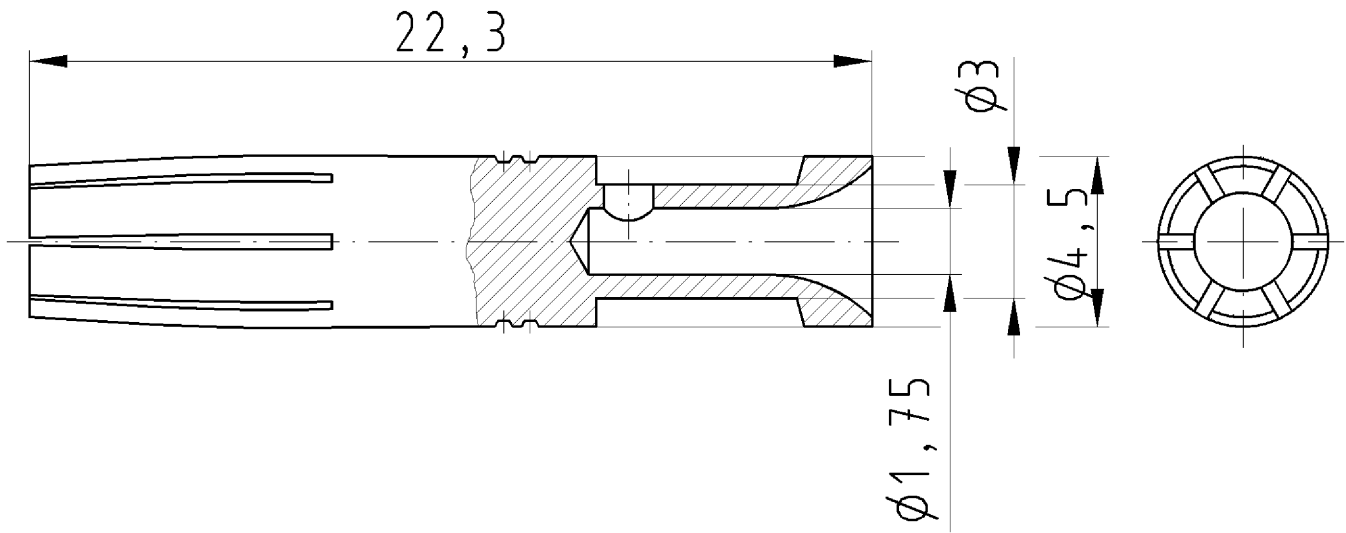

Buchsenkontakt
02.123.7221.0

Zeichnungsnummer
02.123.7221.010W
Buchsenkontakt

19.08.2008
Hoffmann Angelika
M 5:1