

Data sheet

Commercial Art.No.: 25.623.0353.0

PCB connector 8813 B / 3 VR F

PCB female connector with screw connection with rising cage clamp system, 3 poles, printed version, max. cross section: 1.5 mm², pitch: 3.81 mm, type of packing: carton, color: grey

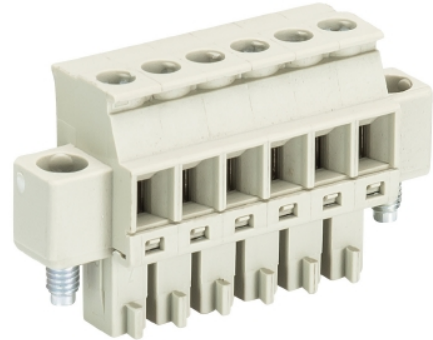

Commercial Art.No.	25.623.0353.0
EAN	4015573560451
Order Unit	100

Certificates / Approvals



Technical data

General

Modular spacing	3.81 mm
Connection type	screw connection
Soldering process	None
Packaging	Carton
Number of poles	3
Marking	yes
Fastening	Flange
Mating direction towards connector	90°

Technical data

Nominal cross section	1.5 mm ²
Rated current	8 A
Overvoltage Category I	690 V
Overvoltage Category II	250 V
Overvoltage Category III	125
Rated impulse voltage	2.5 kV
Wire strip length	6.5 mm

Connection Data

Minimum cross section solid	0.14 mm ²
Maximum cross section solid	1.5 mm ²
Minimum cross section fine stranded	0.14 mm ²
Maximum cross section fine stranded	1.5 mm ²
Wire strip length	6.5 mm

Technical Data UL/CSA

Cross section UL	30-16 AWG
Voltage UL	300 V
Current field wiring	8 A
Current factory wiring	8 A
Cross section CSA	22-14 AWG
Voltage CSA	300 V
Current CSA	5 A

Other

Type of insulation material	Thermoplastic
Color	Grey
Height	19.1 mm
Length	21.82 mm
Depth	10.4 mm
Material attachment screw	Steel
Material contact base	CuSn
Material contact surface	Sn

Classification

ECLASS 11	
ECLASS 8.1	27440402
ETIM 7.0	EC002637
ETIM 6.0	EC002637
ETIM 5.0	EC002637
ETIM 4.0	EC002637

Fits with

Commercial Art.No.:	Article-type description:	Description:
25.627.3353.0	PCB pin header 8813 S / 3 WF OB	PCB pin header with pin header, connection method depends on used socket part , 3 poles, pitch: 3.81 mm, type of packing: carton, color: grey
25.626.3353.0	PCB pin header 8813 S / 3 GF OB	PCB pin header with pin header, connection method depends on used socket part , 3 poles, pitch: 3.81 mm, type of packing: carton, color: grey

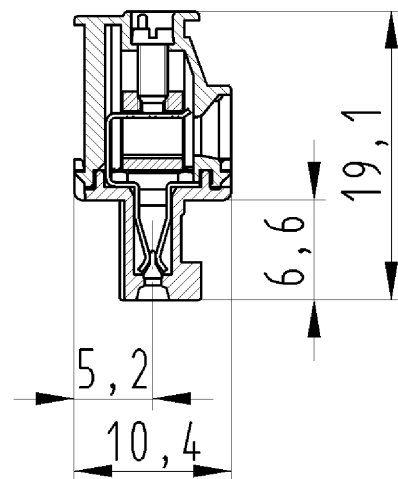
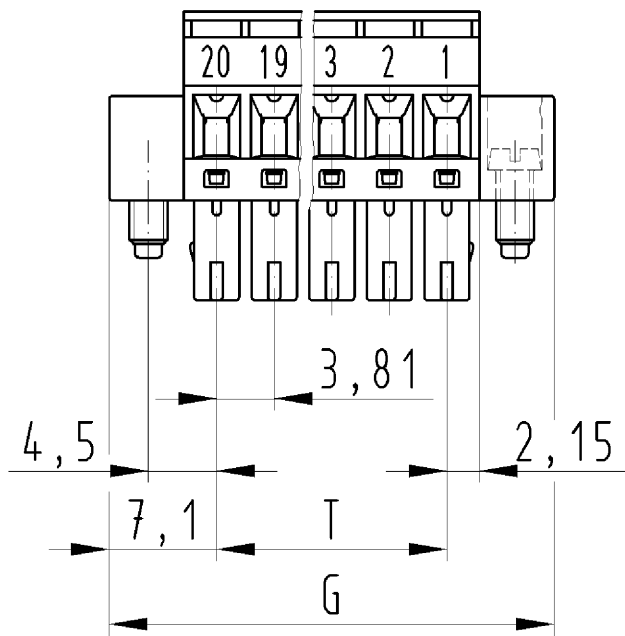

Weitergabe sowie Vervielfältigung dieses Dokuments, Verwertung und Mitteilung seines Inhalts sind verboten, soweit nicht ausdrücklich gestattet. Die Reproduktion, Distribution und Utilization of this document as well as the communication of its contents to others without express authorization is prohibited.

für folgende Tabellen-Zchnng.:
 25.623.0253.0 8813 B/ ...VR F

LP-Steckklemme
 25.623.0253.0 10W
 23.10.2007 DÜT
 M 2:1