



APPLICATION SPECIFICATION

MOLEX MINI 50 0.50mm CONNECTOR SYSTEM

APPLICATION SPECIFICATION



REVISION: L	ECR/ECN INFORMATION: EC No: DATE:	TITLE: Molex MINI 50 0.50mm Connector System Application Specification	SHEET No. 1 of 27
DOCUMENT NUMBER: AS-34791-020	CREATED / REVISED BY: F. PETIT-PIERRE	CHECKED BY: T. MACHUGA	APPROVED BY: R. BAUMAN



APPLICATION SPECIFICATION

REVISION	MODIFICATION	SHEET	DATE
D	Added 12ckt information		2013/07/24
E	Added 12 circuit option information Added CPA option information Added note concerning hinge cracking/breaking		2014/02/05
F	Added service instructions for 4 & 8 circuit connector and SMT header		2014/05/22
G	Adding 16, 20 and 24 ways		2015/09/30
H	Added Best Practices and Troubleshooting section		2016/03/30
I - J	Revision not identify by ECTR release process		
K	Added Electrical probes location	24 - 25	2017/02/16
K1	Added disclaimer regarding pre-seated CPA	7	2017/06/06
K2	Release Error		2017/06/20
L	Adding 2Way connector Adding terminal servicing tool	3-4 22-23	2017/10/19

TABLE OF CONTENTS:

Section 1.0.....SCOPE, pg.3

Section 2.0.....PRODUCT DESCRIPTION, pg. 3

Section 3.0.....REFERENCE DOCUMENTS, pg.5

Section 4.0.....PROCEDURE, pg.6

Section 5.0.....BEST PRACTICES / TROUBLESHOOTING, pg.26

REVISION: L	ECR/ECN INFORMATION: EC No: DATE:	TITLE: Molex MINI 50 0.50mm Connector System Application Specification	SHEET No. 2 of 27
DOCUMENT NUMBER: AS-34791-020	CREATED / REVISED BY: F. PETIT-PIERRE	CHECKED BY: T. MACHUGA	APPROVED BY: R. BAUMAN



APPLICATION SPECIFICATION

1. SCOPE

This procedure applies to all part numbers in the single row series 34791, 34792, 34793, and dual row series 34824, 34825, 34826

2. PRODUCT DESCRIPTION

- 0.50mm terminal system with 1x4, 1x8 and Dual Row 12, 16, 20 and 24 Way
- 4 polarization options for the 1x4 system and 3 polarization option for the 1x8, dual row 12, 16, 20 and 24 Way systems
- Wire range 0.08mm² -- 0.35mm² AS-34791-020
- Utilizes the Molex CTX terminal series 560023

RECEPTACLES

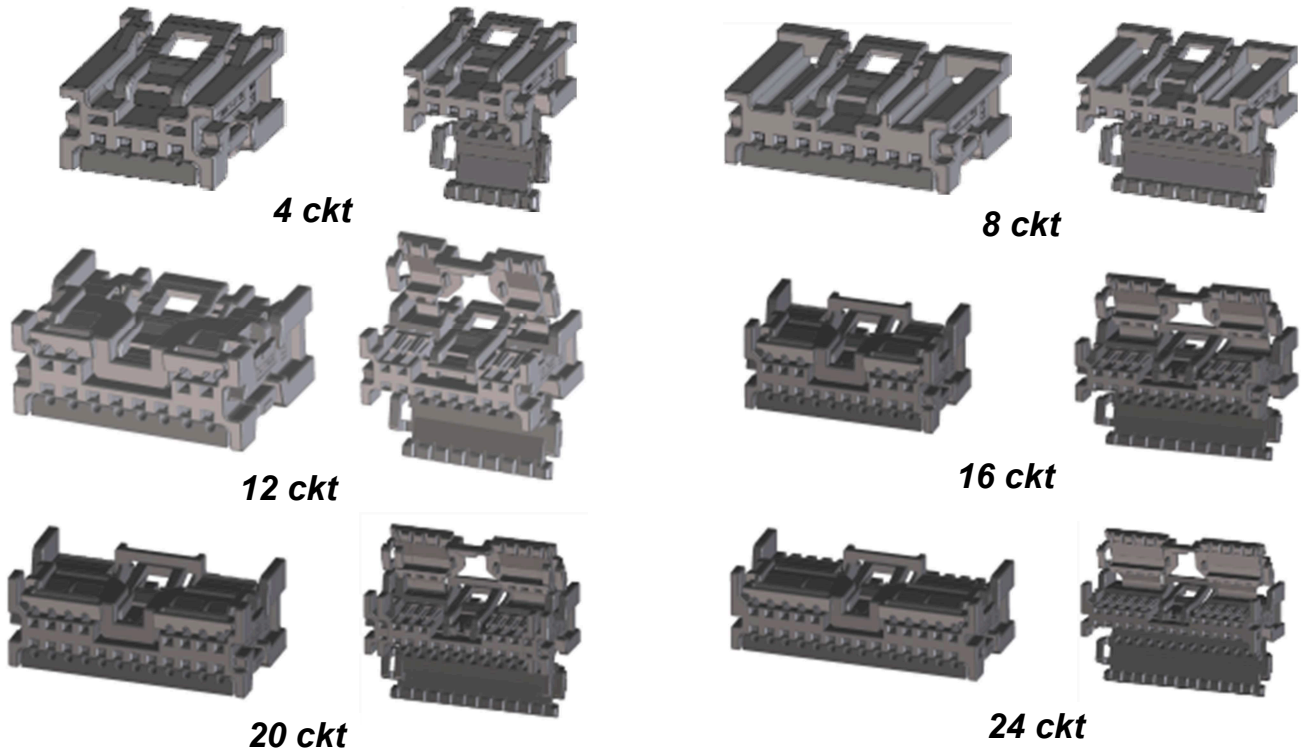

REVISION: L	ECR/ECN INFORMATION: EC No: DATE:	TITLE: Molex MINI 50 0.50mm Connector System Application Specification	SHEET No. 3 of 27
DOCUMENT NUMBER: AS-34791-020	CREATED / REVISED BY: F. PETIT-PIERRE	CHECKED BY: T. MACHUGA	APPROVED BY: R. BAUMAN



APPLICATION SPECIFICATION

HEADERS

Vertical

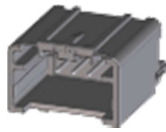

4 ckt

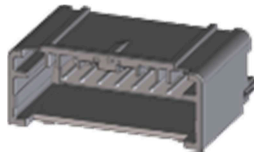

8 ckt

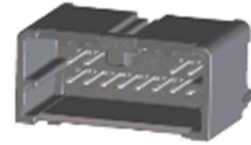

12 ckt



16 ckt



20 ckt



24 ckt

Right Angle

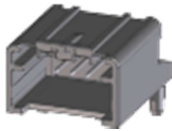

4 ckt

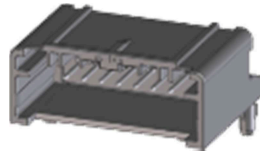

8 ckt

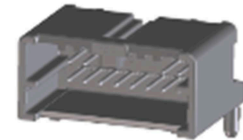

12 ckt



16 ckt

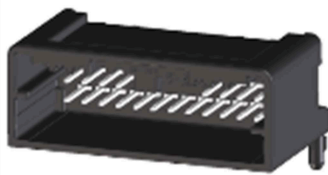

20 ckt



24 ckt

REVISION: L	ECR/ECN INFORMATION: EC No: DATE:	TITLE: Molex MINI 50 0.50mm Connector System Application Specification	SHEET No. 4 of 27
DOCUMENT NUMBER: AS-34791-020	CREATED / REVISED BY: F. PETIT-PIERRE	CHECKED BY: T. MACHUGA	APPROVED BY: R. BAUMAN



APPLICATION SPECIFICATION

3. REFERENCE DOCUMENTS

Single Row Sales Drawing:

- Receptacle – SD-34791-001
- Header (Vertical) – SD-34792-001
- Header (Right Angle) – SD-34793-001

Dual Row Sales Drawing:

- Receptacle – SD-34824-002
- Header (Vertical) – SD-34825-001
- Header (Right Angle) – SD-34826-001

Single/Dual Row CPA Option Sales Drawing:

- Receptacle – SD-34824-003

Connector System Product Specification:

- PS-34791-020

Packaging Drawing:

- Receptacle – PK-31301-538
- Header – PK-31301-440

Terminal System:

- CTX50 Terminal Drawing – SD-560023-002
- CTX50 Product Specification – PS-560023-001

<u>REVISION:</u> L	<u>ECR/ECN INFORMATION:</u> <u>EC No:</u> <u>DATE:</u>	<u>TITLE:</u> Molex MINI 50 0.50mm Connector System Application Specification		<u>SHEET No.</u> 5 of 27
<u>DOCUMENT NUMBER:</u> AS-34791-020		<u>CREATED / REVISED BY:</u> F. PETIT-PIERRE	<u>CHECKED BY:</u> T. MACHUGA	<u>APPROVED BY:</u> R. BAUMAN



APPLICATION SPECIFICATION

4. PROCEDURE

A. Connector “As Shipped”

Connector ISL shown in “as shipped” condition (open). The ISL must remain in the open position until all circuits are loaded.

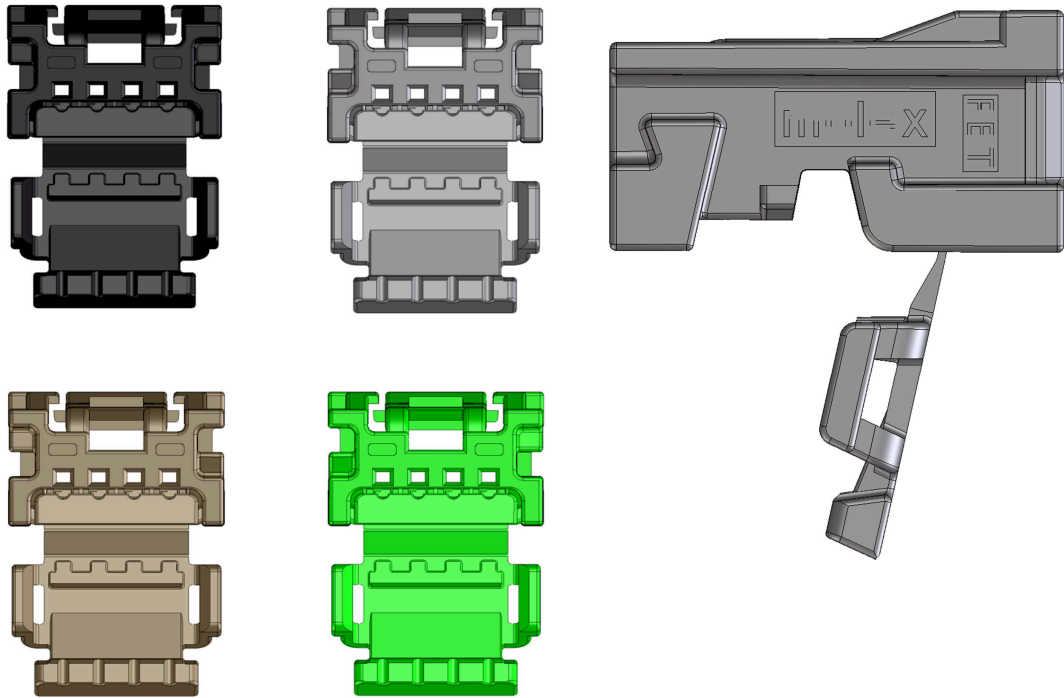

B. ISL “lift to open”

ISL must be in pre-lock position to populate the connector. If during shipping the Connector ISL moves from its pre-lock position. Simply slide a small screwdriver (width 2-2.5mm) behind the latch on each side of the connector and pry to open the ISL

IF THE ISL OR HOUSING IS DAMAGED IN ANY WAY, DO NOT USE THE CONNECTOR

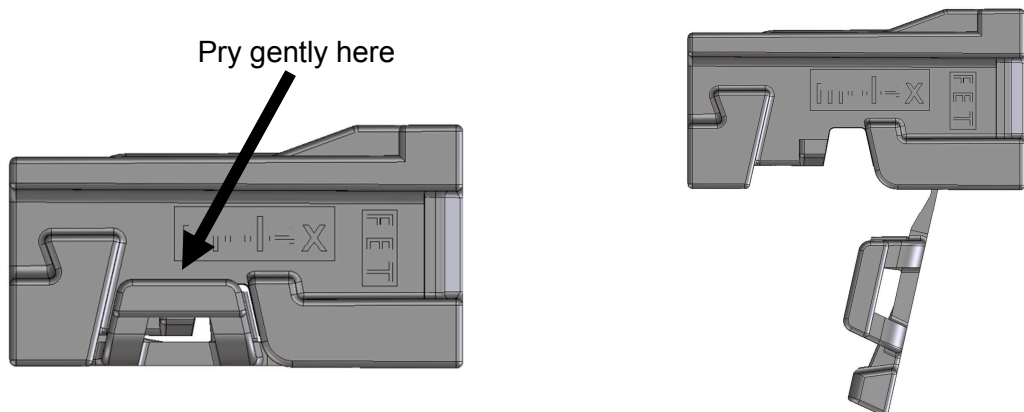

REVISION: L	ECR/ECN INFORMATION: EC No: DATE:	TITLE: Molex MINI 50 0.50mm Connector System Application Specification	SHEET No. 6 of 27
DOCUMENT NUMBER: AS-34791-020	CREATED / REVISED BY: F. PETIT-PIERRE	CHECKED BY: T. MACHUGA	APPROVED BY: R. BAUMAN



APPLICATION SPECIFICATION

C. Terminal Installation

There is a very low probability that a CPA will seat during transit. If this occurs, DO NOT populate the connector. Please scrap that specific connector. Otherwise, with ISL still in pre-lock position, orient the terminal to the rear of connector as shown below. Grip the wire behind the terminal insulation crimp and insert it through the appropriate circuit opening. If resistance is encountered, retract the terminal and adjust the angle of insertion. Continue inserting the terminal until it stops and locks up on the lock finger with an audible click or tactile feedback.

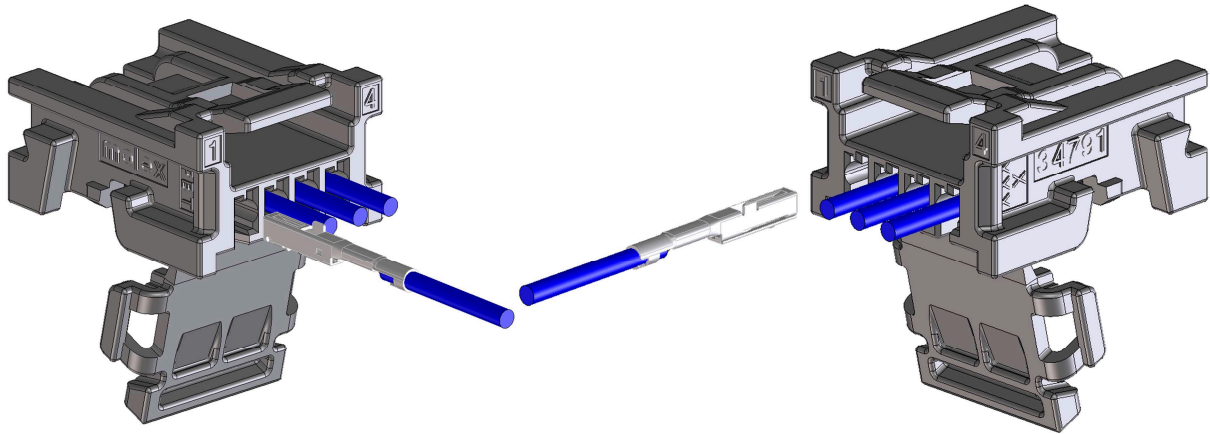

ISL MUST BE IN OPEN POSITION TO POPULATE THE CONNECTOR

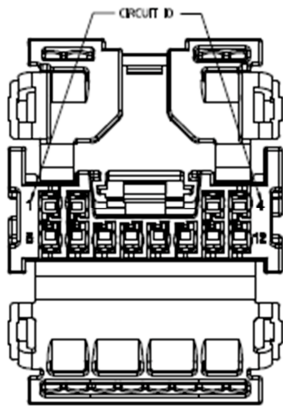

12ckt receptacle shown above as reference.
The 16, 20, and 24ckt receptacles have similar circuit IDs

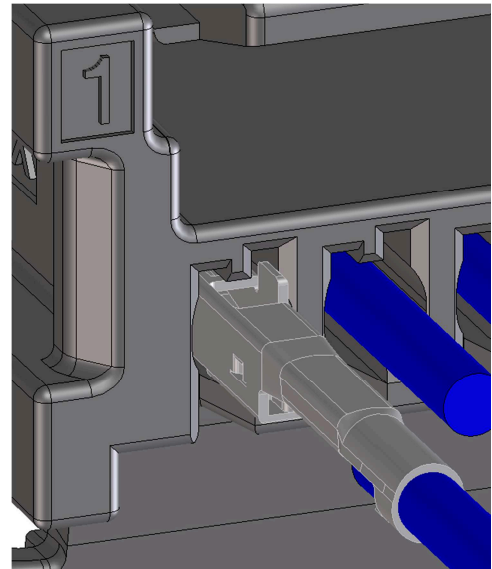

REVISION: L	ECR/ECN INFORMATION: EC No: DATE:	TITLE: Molex MINI 50 0.50mm Connector System Application Specification	SHEET No. 7 of 27
DOCUMENT NUMBER: AS-34791-020	CREATED / REVISED BY: F. PETIT-PIERRE	CHECKED BY: T. MACHUGA	APPROVED BY: R. BAUMAN



APPLICATION SPECIFICATION

C. Terminal Installation (continued)

Installing a terminal correctly will have low effort.

Improperly installing a terminal 180° will lead to a high effort and wire buckle.

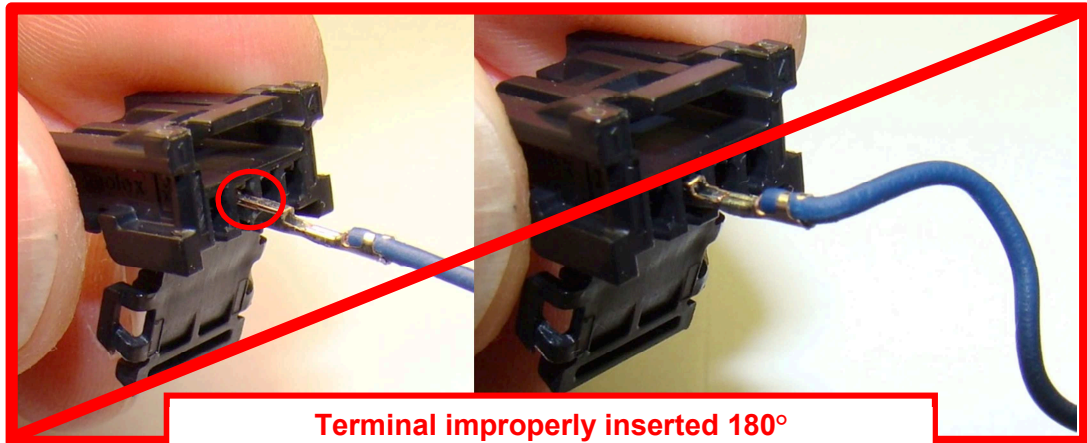
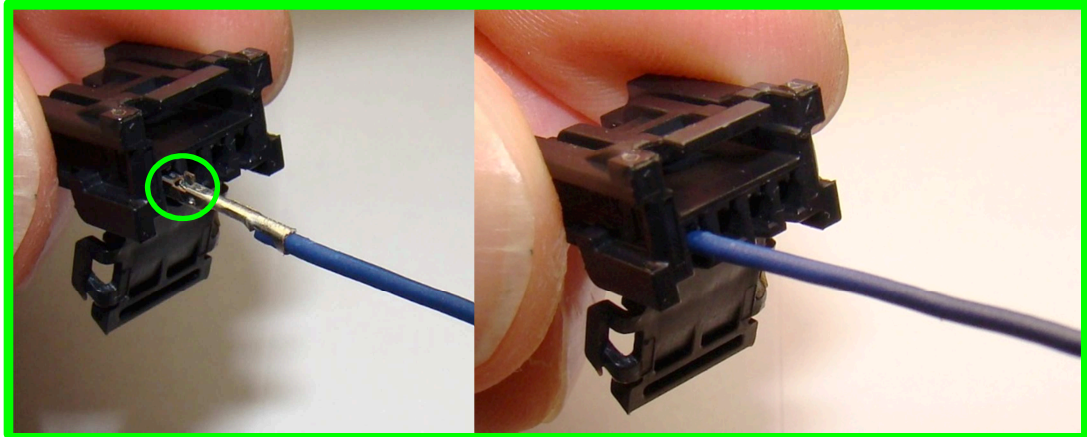

**Terminal improperly inserted 180°
NOTE WIRE BUCKLE**

REVISION: L	ECR/ECN INFORMATION: EC No: DATE:	TITLE: Molex MINI 50 0.50mm Connector System Application Specification	SHEET No. 8 of 27
DOCUMENT NUMBER: AS-34791-020	CREATED / REVISED BY: F. PETIT-PIERRE	CHECKED BY: T. MACHUGA	APPROVED BY: R. BAUMAN



APPLICATION SPECIFICATION

D. Closing the ISL

Once all terminals are installed:

- 1.) Perform a visual check to confirm terminals are fully seated and in the correct position
- 2.) Close the ISL by applying force to the hinged portion of the connector
- 3.) The ISL will "click" into its final position
- 4.) Gently pull down on the front of the ISL to confirm it is properly closed

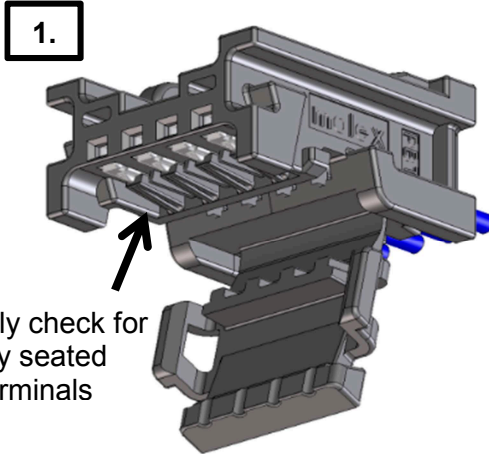

Visually check for fully seated terminals

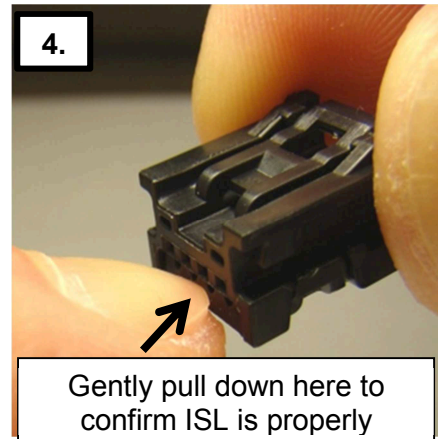
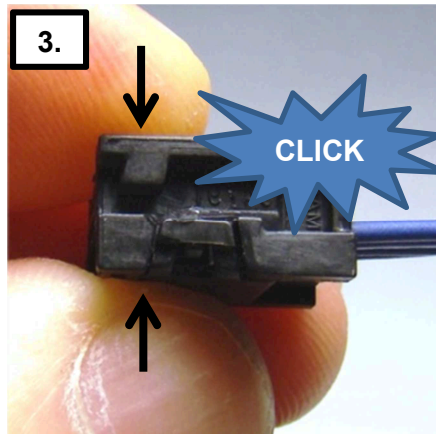
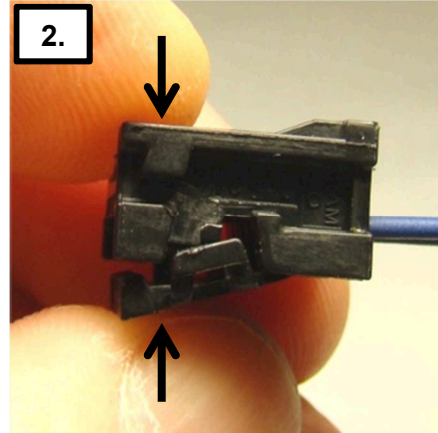

Gently pull down here to confirm ISL is properly

NOTE REGARDING THE ISL:
 WHILE CYCLING THE HINGE, THE USER MAY NOTICE STRESS LINES OR DELAMINATION IN THE AREA SHOWN BELOW. THIS WILL NOT AFFECT THE FUNCTION OF THE CONNECTOR IN ANY WAY. THE ISL WILL CONTINUE TO FUNCTION 100% EVEN IF THE HINGE IS COMPLETELY SEPERATED FROM THE CONNECTOR BODY.

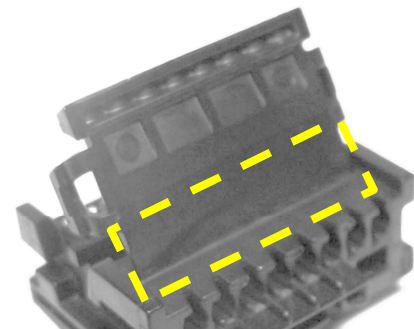

Stress lines or delamination in this area of the hinge may be noticed, but it will not affect the function of the ISL

REVISION: L	ECR/ECN INFORMATION: EC No: DATE:	TITLE: Molex MINI 50 0.50mm Connector System Application Specification	SHEET No. 9 of 27
DOCUMENT NUMBER: AS-34791-020	CREATED / REVISED BY: F. PETIT-PIERRE	CHECKED BY: T. MACHUGA	APPROVED BY: R. BAUMAN



APPLICATION SPECIFICATION

E. Detecting a partially installed terminal

The ISL will not close with a partially installed terminal. If the ISL will not close, confirm all terminals are fully installed. The operator will not be able to mate the connector to the header if the ISL is not closed.

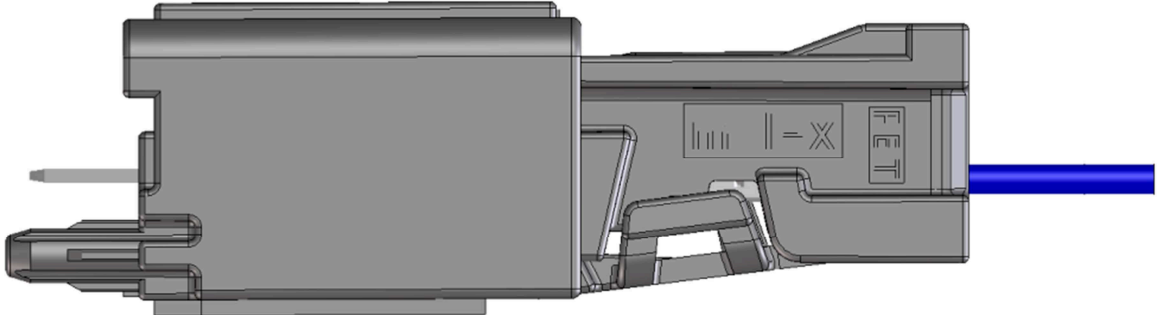

DO NOT FORCE THE ISL CLOSED WHEN THERE ARE PARTIALLY INSTALLED TERMINALS OR DAMAGE TO THE TERMINAL AND CONNECTOR ISL MAY OCCUR

REVISION: L	ECR/ECN INFORMATION: EC No: DATE:	TITLE: Molex MINI 50 0.50mm Connector System Application Specification	SHEET No. 10 of 27
DOCUMENT NUMBER: AS-34791-020	CREATED / REVISED BY: F. PETIT-PIERRE	CHECKED BY: T. MACHUGA	APPROVED BY: R. BAUMAN



APPLICATION SPECIFICATION

F. Connector Mating

To properly mate the connector:

- 1.) First align the keying features from the receptacle connector to the mating header
- 2.) Slide the receptacle connector fully into the header assembly until you hear an audible “click”

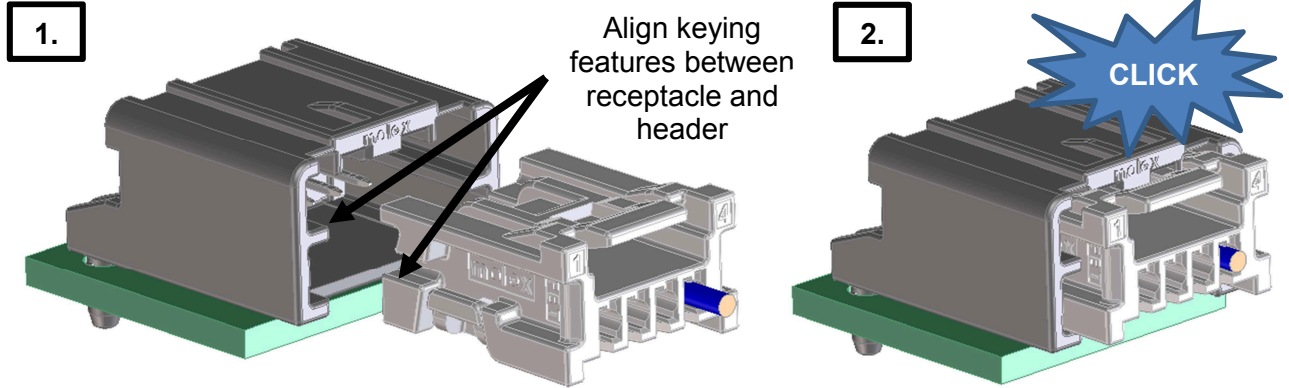

If resistance is encountered during mating, confirm the ISL is fully locked and all terminals are fully installed (See Section E. Detecting a partially installed terminal).

REVISION: L	ECR/ECN INFORMATION: EC No: DATE:	TITLE: Molex MINI 50 0.50mm Connector System Application Specification	SHEET No. 11 of 27
DOCUMENT NUMBER: AS-34791-020	CREATED / REVISED BY: F. PETIT-PIERRE	CHECKED BY: T. MACHUGA	APPROVED BY: R. BAUMAN



APPLICATION SPECIFICATION

F. Connector Mating (continued)

Never mate the system at an angle or with bias. This may cause damage to the header or connector.

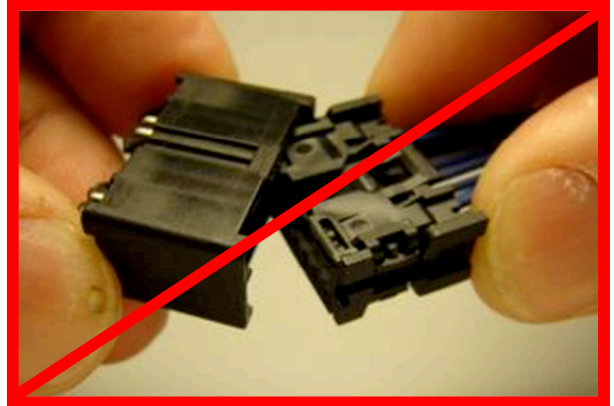
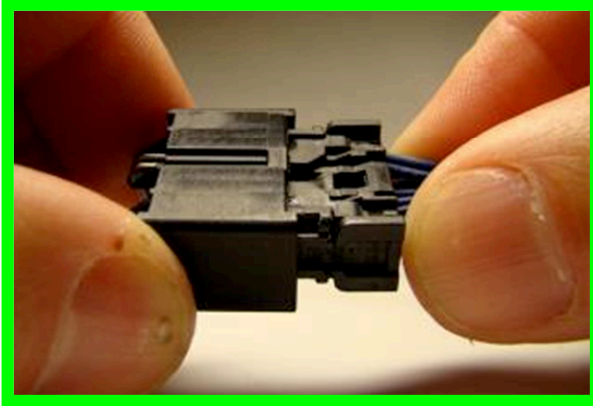

Always push on the connector housing while mating.

DO NOT PUSH ON THE LATCH WHILE MATING

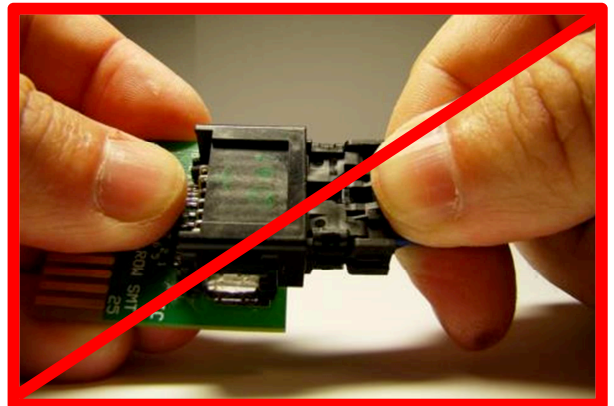
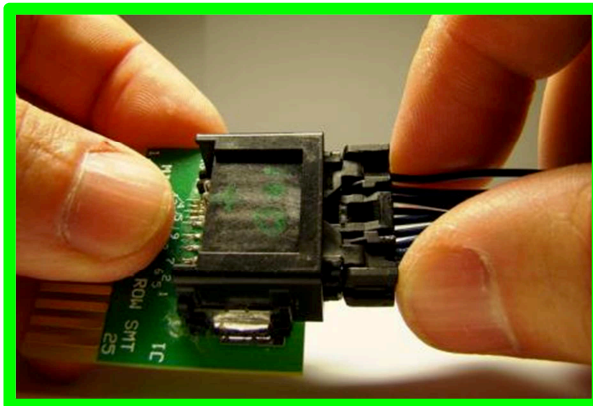

When mating the connector with a CPA:

- 1.) Align the connector and push evenly on the connector body to mate.
DO NOT PUSH ON THE CPA DURING THE MATING PROCESS.
- 2.) After mating the connector, push on the CPA to engage.
- 3.) Check to ensure the CPA is fully seated.

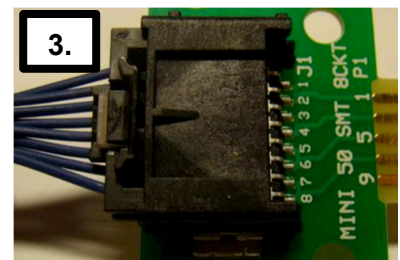
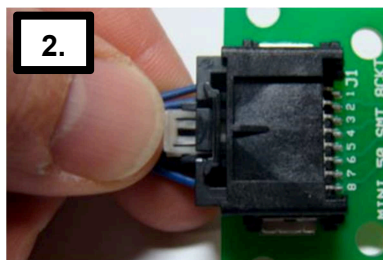
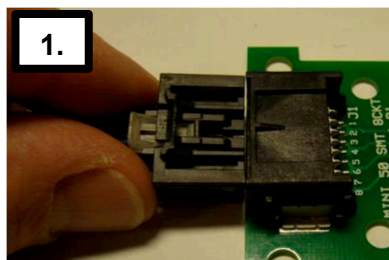

REVISION: L	ECR/ECN INFORMATION: EC No: DATE:	TITLE: Molex MINI 50 0.50mm Connector System Application Specification	SHEET No. 12 of 27
DOCUMENT NUMBER: AS-34791-020	CREATED / REVISED BY: F. PETIT-PIERRE	CHECKED BY: T. MACHUGA	APPROVED BY: R. BAUMAN



APPLICATION SPECIFICATION

G. Connector Un-mating

To un-mate the connectors, push connectors together to unload the latch system, then:

- 1.) Depress the latch with your thumb.
- 2.) Continue to depress the latch, and gently pull apart connector assemblies.

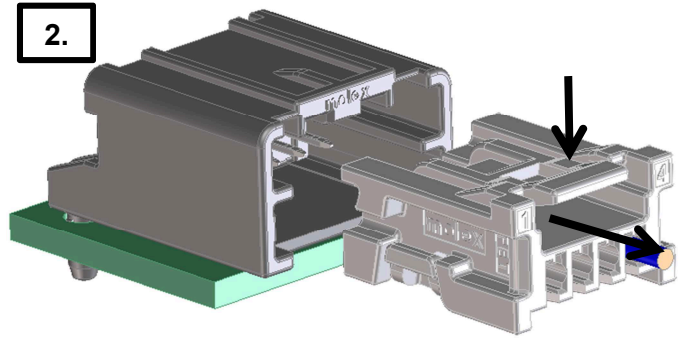
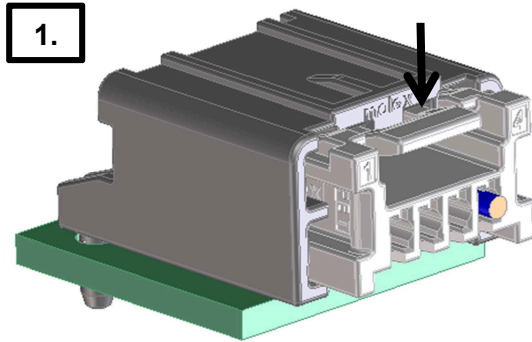

When un-mating the connector with a CPA:

- 1.) Use a small flat tip screwdriver (width 2-2.5mm) to disengage the CPA
- 2.) Push connectors together to unload the latch system, then depress the latch with your thumb.
- 3.) Continue to depress the latch, and gently pull apart connector assemblies.

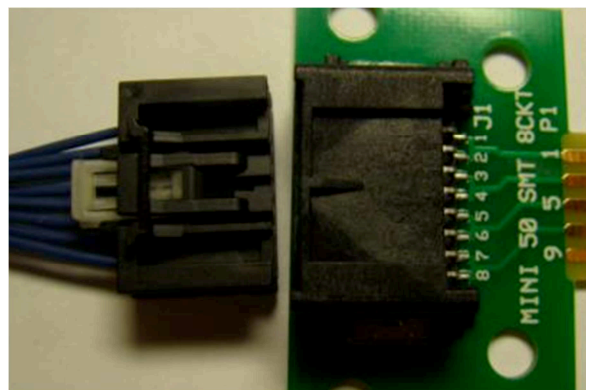
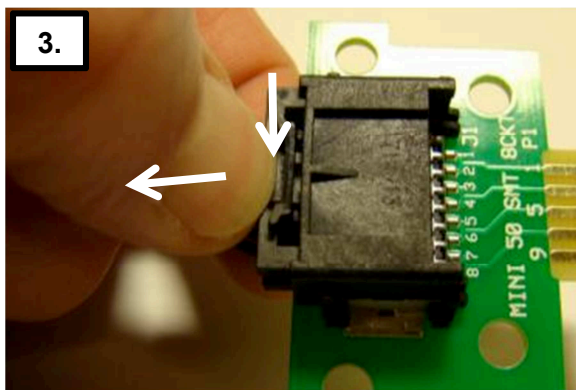
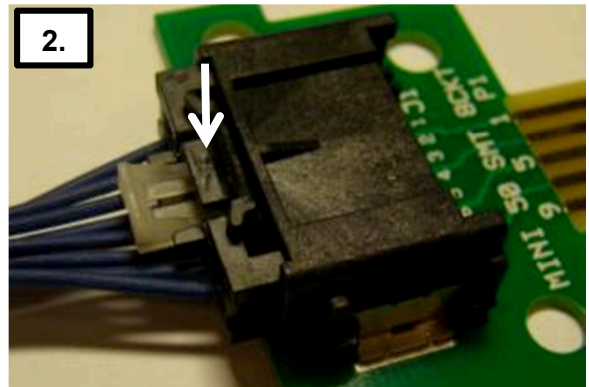
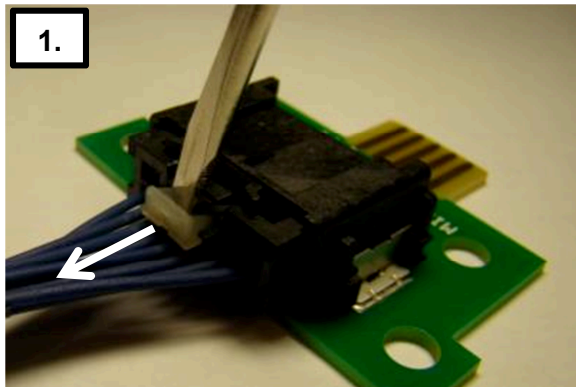

REVISION: L	ECR/ECN INFORMATION: EC No: DATE:	TITLE: Molex MINI 50 0.50mm Connector System Application Specification	SHEET No. 13 of 27
DOCUMENT NUMBER: AS-34791-020	CREATED / REVISED BY: F. PETIT-PIERRE	CHECKED BY: T. MACHUGA	APPROVED BY: R. BAUMAN



APPLICATION SPECIFICATION

G. Connector Un-mating (continued)

If difficulty is encountered while attempting to un-mate the connector from an SMT header, the following procedure may be used:

- 1.) Use a small flat tip screwdriver (width 2-2.5mm) to disengage the CPA
- 2.) Push connectors together to unload the latch system, then insert a small flat tip screwdriver (width 2-2.5mm) between the latch and the latch cover.
- 3.) While pressing down on the latch with the screwdriver (width 2-2.5mm), gently pull on the wire bundle and the screwdriver (width 2-2.5mm) to remove the connector

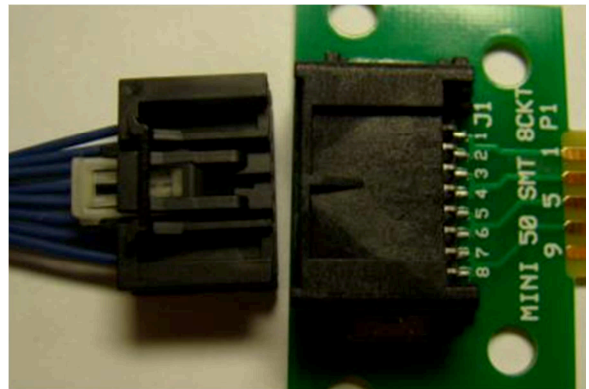
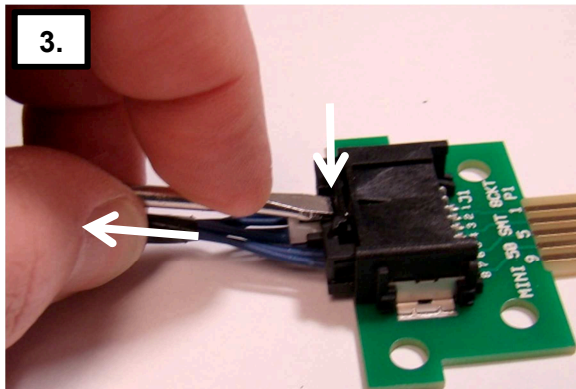
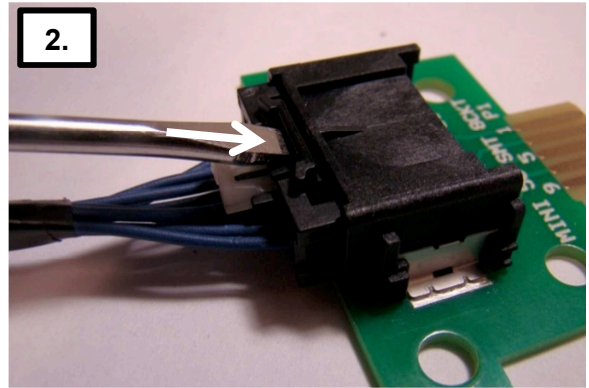
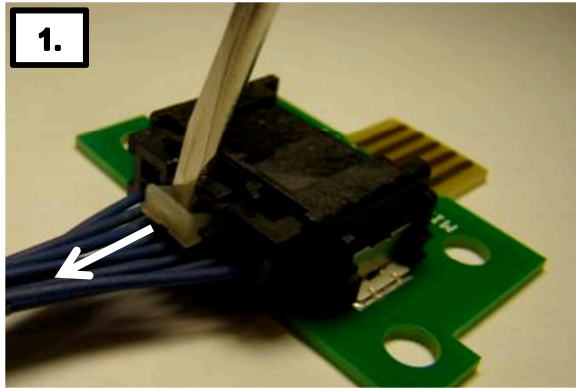

REVISION: L	ECR/ECN INFORMATION: EC No: DATE:	TITLE: Molex MINI 50 0.50mm Connector System Application Specification	SHEET No. 14 of 27
DOCUMENT NUMBER: AS-34791-020	CREATED / REVISED BY: F. PETIT-PIERRE	CHECKED BY: T. MACHUGA	APPROVED BY: R. BAUMAN



APPLICATION SPECIFICATION

H. Opening the ISL

Use a small flat tip screwdriver (width 2-2.5mm) to gently pry on the ISL latch features one side at a time. Once each ISL latch is released, the ISL will open.

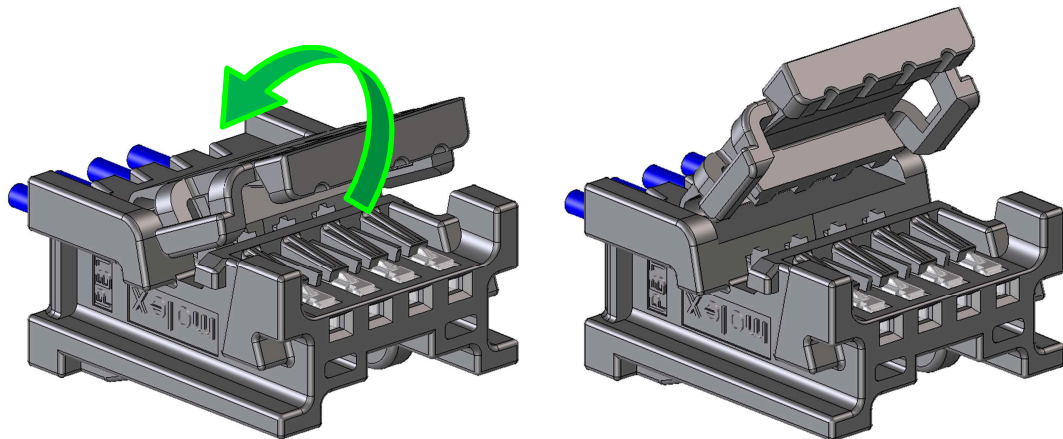
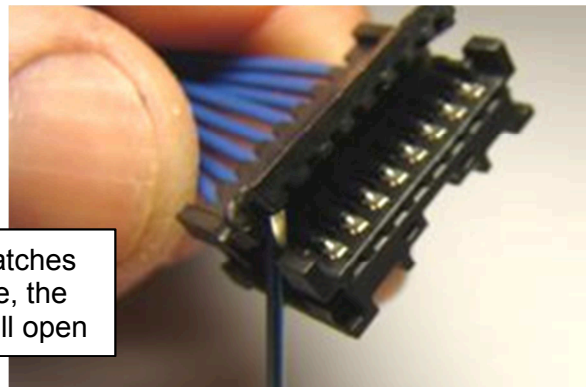
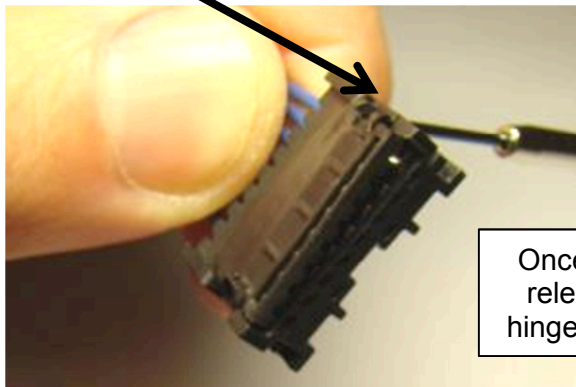
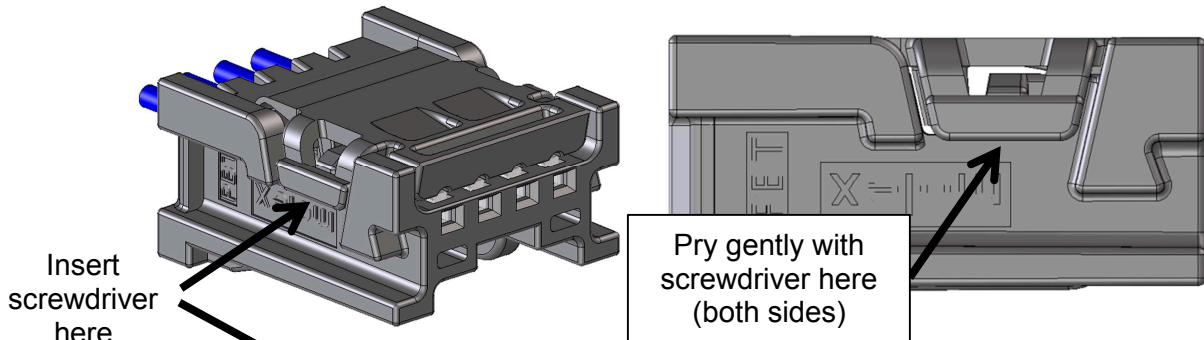

REVISION: L	ECR/ECN INFORMATION: EC No: DATE:	TITLE: Molex MINI 50 0.50mm Connector System Application Specification	SHEET No. 15 of 27
DOCUMENT NUMBER: AS-34791-020	CREATED / REVISED BY: F. PETIT-PIERRE	CHECKED BY: T. MACHUGA	APPROVED BY: R. BAUMAN



APPLICATION SPECIFICATION

I. Terminal Servicing

Use service tool #63813-XXXX with marking facing up. Position it on the end of the latch with 45° angle. Then rotate the tool until horizontal direction WITHOUT pushing on the latch

With a small thumbtack gently pry up on the terminal lock finger. Once the lock finger is released, pull on the terminal to remove it from the housing

THE CONNECTOR HOUSING MAY BE DAMAGED WITH IMPROPER SERVICING. INSPECT THE TERMINAL, HOUSING, AND LOCK FINGER FOR DAMAGE AND REPLACE THE CONNECTOR IF DAMAGE IS EVIDENT. THE CONNECTOR HOUSING CAN BE SERVICE UP TO TWO TIMES, THEN IT MUST BE REPLACED.

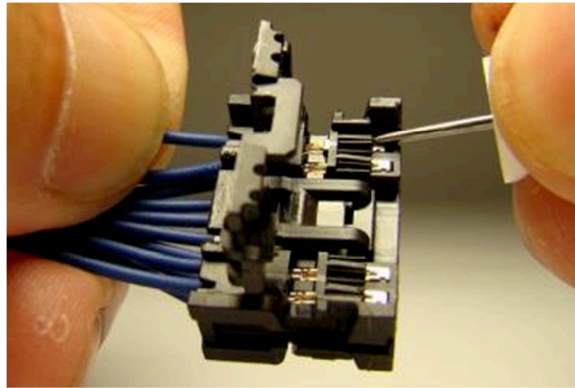

REVISION: L	ECR/ECN INFORMATION: EC No: DATE:	TITLE: Molex MINI 50 0.50mm Connector System Application Specification	SHEET No. 16 of 27
DOCUMENT NUMBER: AS-34791-020	CREATED / REVISED BY: F. PETIT-PIERRE	CHECKED BY: T. MACHUGA	APPROVED BY: R. BAUMAN



APPLICATION SPECIFICATION

J. Electrical Probing / Continuity Checking

The preferred method of probing is to use the dedicated probe hole opening to check for electrical continuity. Use a 0.66mm (Lone Star part number LS040-MR-719), pin or smaller equivalent to prevent damaging the terminal.

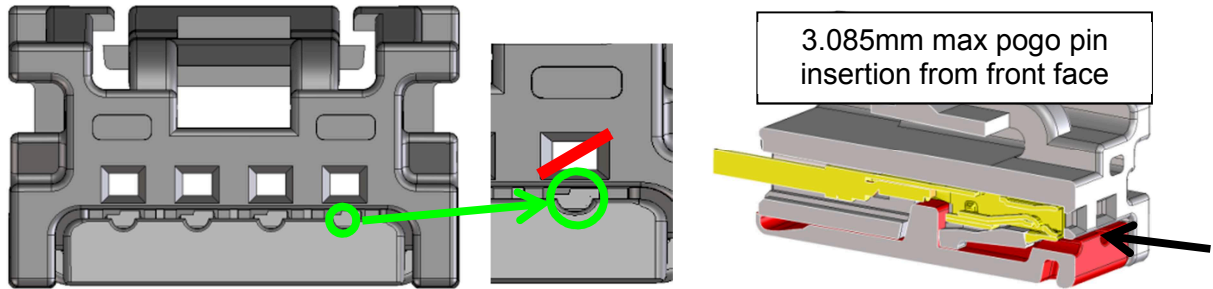

SINGLE ROW PROBE HOLE LOCATIONS

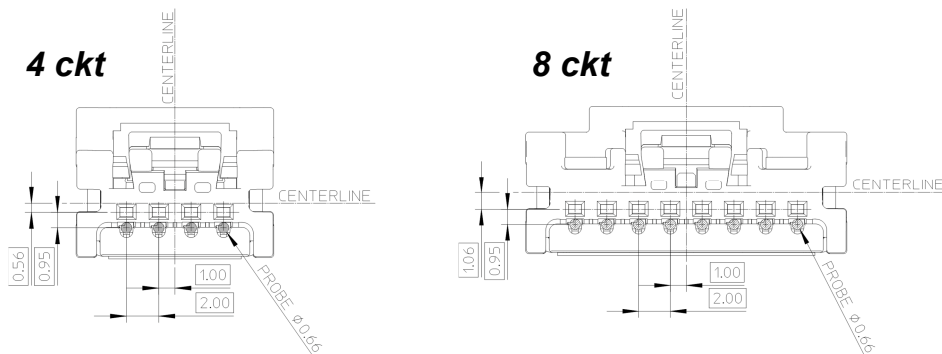

DUAL ROW PROBE HOLE LOCATIONS

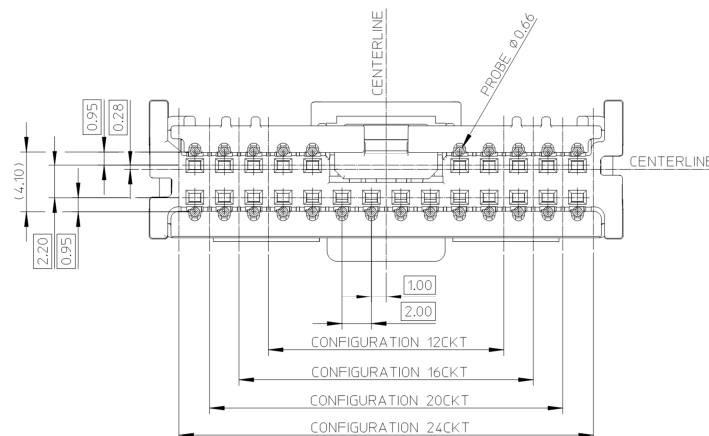

REVISION: L	ECR/ECN INFORMATION: EC No: DATE:	TITLE: Molex MINI 50 0.50mm Connector System Application Specification	SHEET No. 17 of 27
DOCUMENT NUMBER: AS-34791-020	CREATED / REVISED BY: F. PETIT-PIERRE	CHECKED BY: T. MACHUGA	APPROVED BY: R. BAUMAN



APPLICATION SPECIFICATION

K. Post Solder Reflow Measurements

Header warpage during reflow soldering is expected. If the below dimension becomes less than 7.90mm, confirm processing temperatures are in accordance with SMES-152. The product is designed for a peak temp of 260°C is allowed.

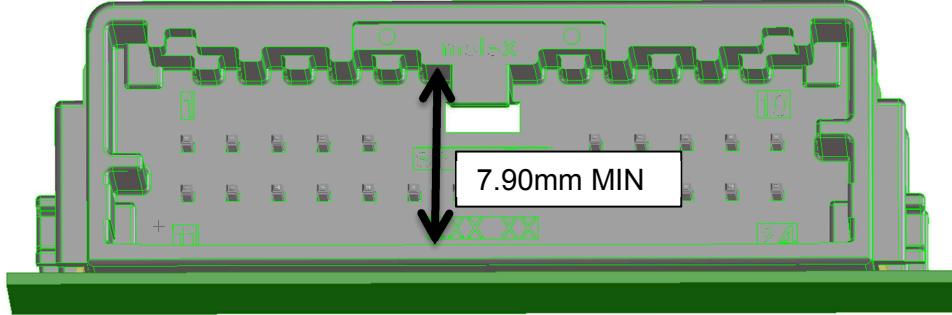

REVISION: L	ECR/ECN INFORMATION: EC No: DATE:	TITLE: Molex MINI 50 0.50mm Connector System Application Specification	SHEET No. 18 of 27
DOCUMENT NUMBER: AS-34791-020	CREATED / REVISED BY: F. PETIT-PIERRE	CHECKED BY: T. MACHUGA	APPROVED BY: R. BAUMAN



APPLICATION SPECIFICATION

5. BEST PRACTICES / TROUBLESHOOTING

A. Connector “As Shipped”

Connector ISL shown in “as shipped” condition (open). The ISL must remain in the open position

REVISION: L	ECR/ECN INFORMATION: EC No: DATE:	TITLE: Molex MINI 50 0.50mm Connector System Application Specification	SHEET No. 19 of 27
DOCUMENT NUMBER: AS-34791-020	CREATED / REVISED BY: F. PETIT-PIERRE	CHECKED BY: T. MACHUGA	APPROVED BY: R. BAUMAN



APPLICATION SPECIFICATION

- I. Terminal servicing
I-1 Recommended service tool :

Marking on top

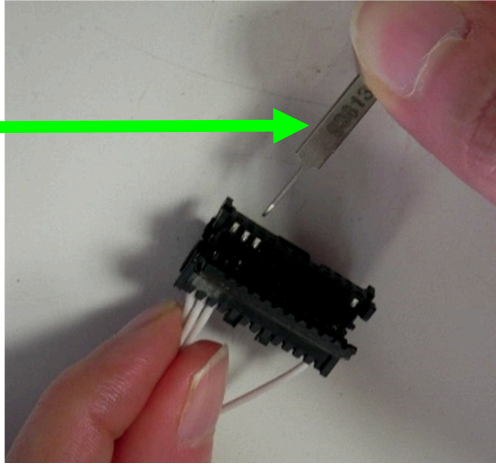

45° orientation

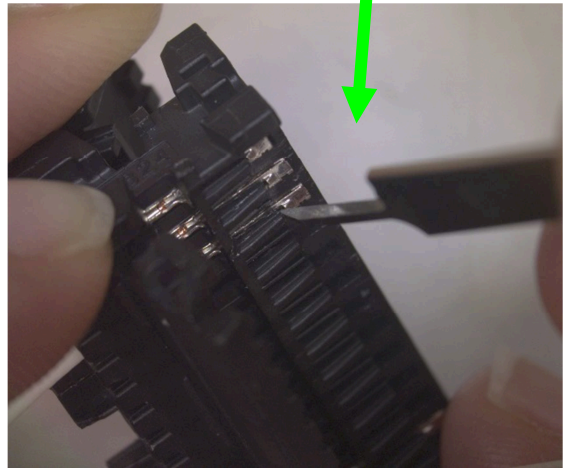

Use the service tool #63813-XXXX with marking on top. Position it on the end of the latch with 45° angle. Then rotate the tool until horizontal direction WITHOUT pushing on the latch.

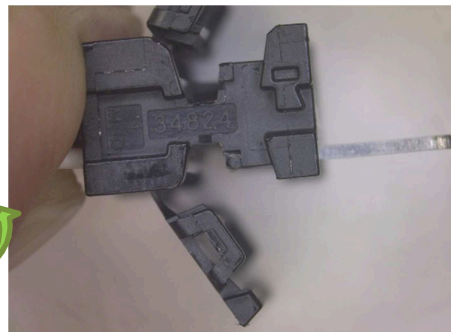

Rotate tool

REVISION: L	ECR/ECN INFORMATION: EC No: DATE:	TITLE: Molex MINI 50 0.50mm Connector System Application Specification	SHEET No. 20 of 27
DOCUMENT NUMBER: AS-34791-020	CREATED / REVISED BY: F. PETIT-PIERRE	CHECKED BY: T. MACHUGA	APPROVED BY: R. BAUMAN



APPLICATION SPECIFICATION



Gently pull on the terminal

Gently pull on the wire to release the terminal

Connector housing can be serviced up to two times, then it must be replaced.

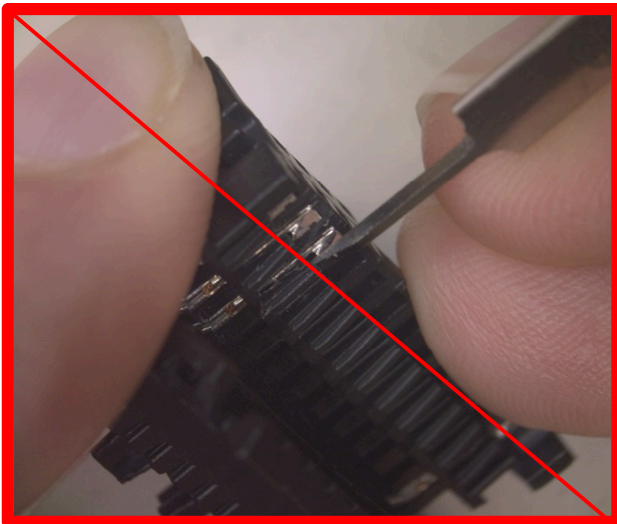

Don't push the tool under the latch. It will damage the terminal and the connector.

Never insert the tool in the terminal cavity. It will damage the terminal and the connector.

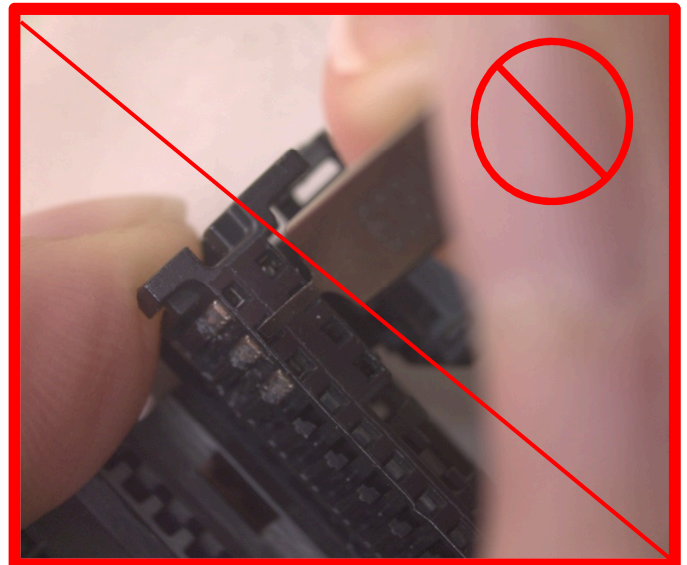

REVISION: L	ECR/ECN INFORMATION: EC No: DATE:	TITLE: Molex MINI 50 0.50mm Connector System Application Specification	SHEET No. 21 of 27
DOCUMENT NUMBER: AS-34791-020	CREATED / REVISED BY: F. PETIT-PIERRE	CHECKED BY: T. MACHUGA	APPROVED BY: R. BAUMAN



APPLICATION SPECIFICATION

6. BEST PRACTICES / TROUBLESHOOTING

Steps can be taken during harness assembly that can ensure the successful product usage by the customer. Terminal crimping that is in accordance with the CTX50 terminal application specification, AS-560023-001, has been found to prevent assembly issues such as bent header pins, pushed-out header pins, ISL bowing, and terminal stubbing. Examples of good and bad terminals and issues attributed to bad terminals are shown in the following pages

A. Observed issues attributed to improperly crimped and/or bent female terminals:

A1. Pushed-Out Header Pin:

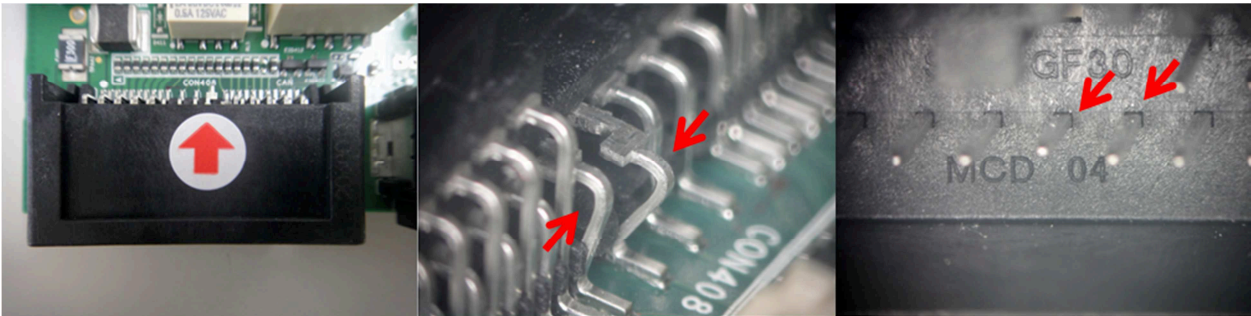

A2. ISL Bow (due to improperly crimped and/or bent terminals):

BAD Connector causing pushed-out pins, with improperly crimped and/or bent terminals:

GOOD connector with in-spec terminals:

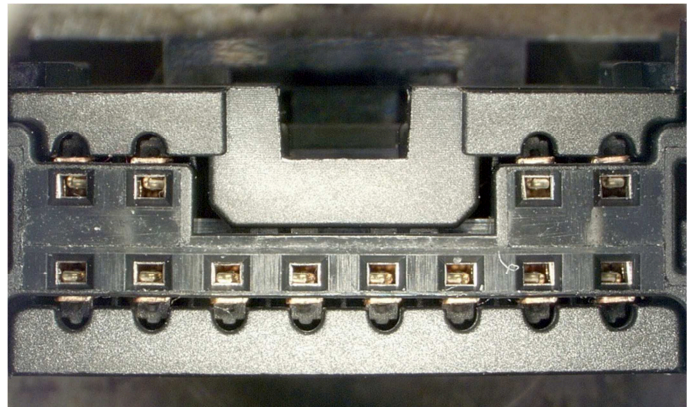

REVISION: L	ECR/ECN INFORMATION: EC No: DATE:	TITLE: Molex MINI 50 0.50mm Connector System Application Specification	SHEET No. 22 of 27
DOCUMENT NUMBER: AS-34791-020	CREATED / REVISED BY: F. PETIT-PIERRE	CHECKED BY: T. MACHUGA	APPROVED BY: R. BAUMAN



APPLICATION SPECIFICATION

BAD: Improperly positioned terminals

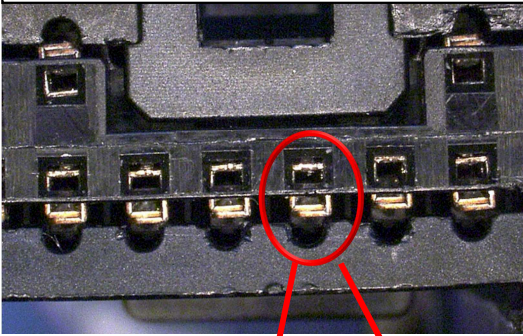

GOOD: Terminals correctly crimped and positioned – No ISL Bow

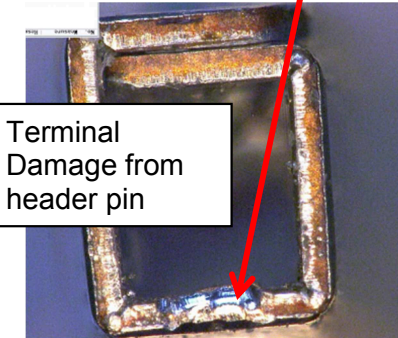

Terminal Damage from header pin

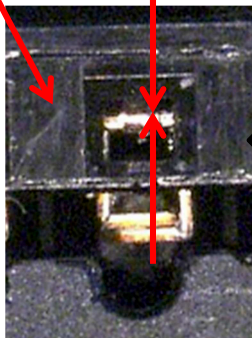

If the front edge of the terminal box can be seen through the connector cavity front window as shown in the picture below, terminal crimp dimensions shown on page 28 should be confirmed to meet AS-34791-020.

A3. Excessive Wire Brush:



Excessive Wire Brush

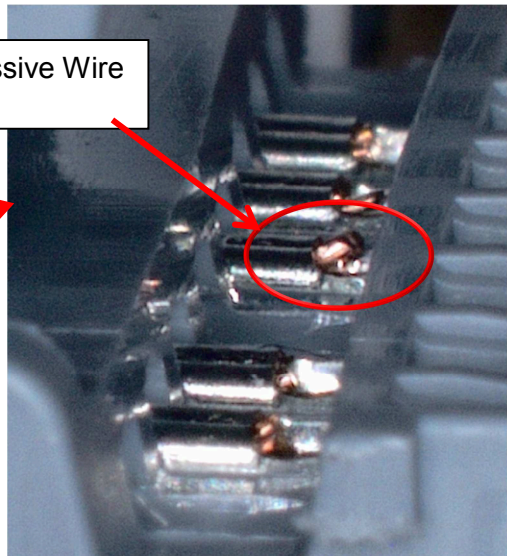

BAD - ISL Bowing caused by excessive wire brush:

REVISION: L	ECR/ECN INFORMATION: EC No: DATE:	TITLE: Molex MINI 50 0.50mm Connector System Application Specification	SHEET No. 23 of 27
DOCUMENT NUMBER: AS-34791-020	CREATED / REVISED BY: F. PETIT-PIERRE	CHECKED BY: T. MACHUGA	APPROVED BY: R. BAUMAN



APPLICATION SPECIFICATION

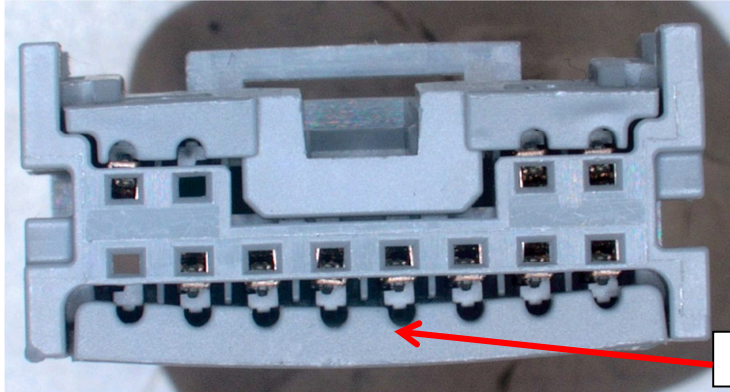

ISL Bowing

GOOD - Connector with in-spec terminals:

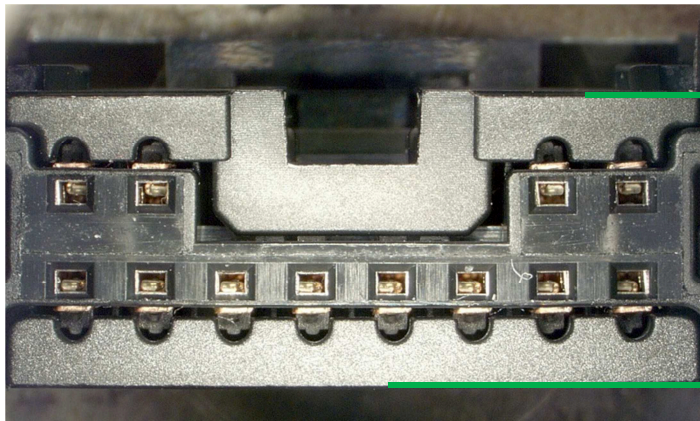

(8.2mm) MAX

Finished harness assembly should not exceed 8.2mm Max

Excessive Wire Brush can lead to ISL Bowing by interfering with ISL when ISL is closed. ISL bowing can cause bent or pushed-out header pins.

A4. Excessive Crimp Bulge:

REVISION: L	ECR/ECN INFORMATION: EC No: DATE:	TITLE: Molex MINI 50 0.50mm Connector System Application Specification	SHEET No. 24 of 27
DOCUMENT NUMBER: AS-34791-020	CREATED / REVISED BY: F. PETIT-PIERRE	CHECKED BY: T. MACHUGA	APPROVED BY: R. BAUMAN



APPLICATION SPECIFICATION

GOOD- Molex crimped terminal – clearance w/cavity

BAD – Non-conforming crimped terminals

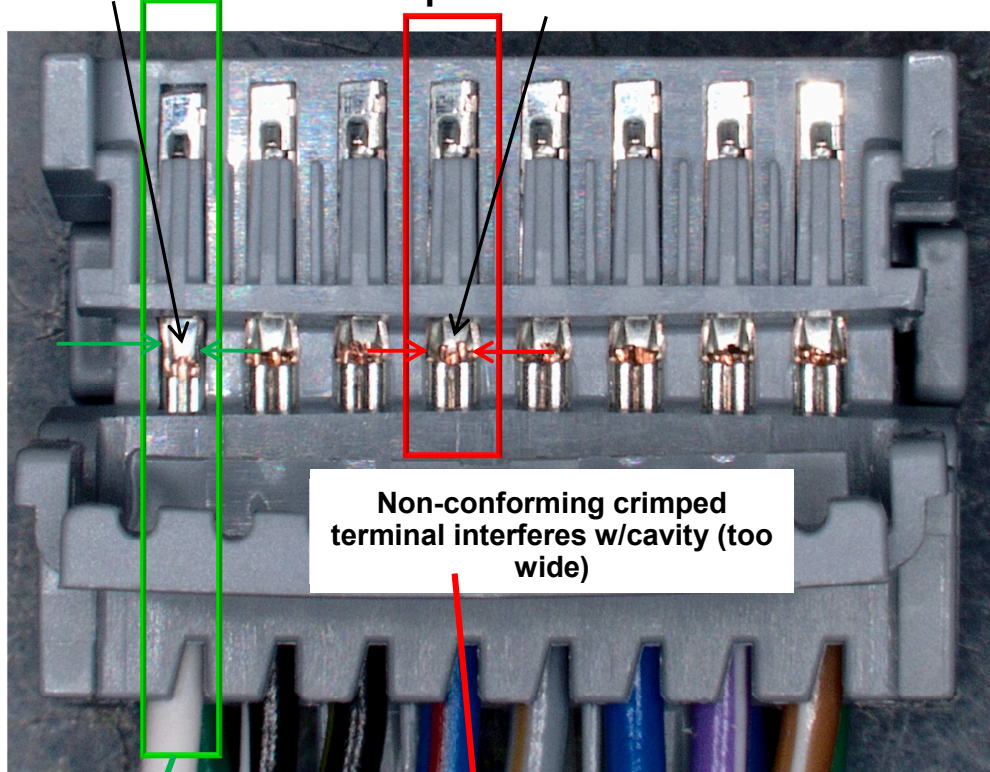

GOOD – In-spec Crimp Bulge



BAD – Excessive Crimp Bulge

Excessive crimp bulge can lead to mis-aligned, improperly positioned terminals within the connector cavity, and can contribute to ISL bowing and bent or pushed-out header pins.

A5. Test Harness Cautions:

REVISION: L	ECR/ECN INFORMATION: EC No: DATE:	TITLE: Molex MINI 50 0.50mm Connector System Application Specification	SHEET No. 25 of 27
DOCUMENT NUMBER: AS-34791-020	CREATED / REVISED BY: F. PETIT-PIERRE	CHECKED BY: T. MACHUGA	APPROVED BY: R. BAUMAN



APPLICATION SPECIFICATION

Repetitive use of Mini50 connectors in test harnesses require monitoring of the female connector for damage to the lead-ins on the mating face of the connector. Refer to the picture below for examples of the type of damage that can occur, in which the lead-in is bent out of the way or worn out due to repetitive mating. The absence of a lead-in can cause pin stubbing against the female terminal, bent header pins, pushed-out header pins, or connector stubbing. Test connectors should be inspected and replaced frequently.

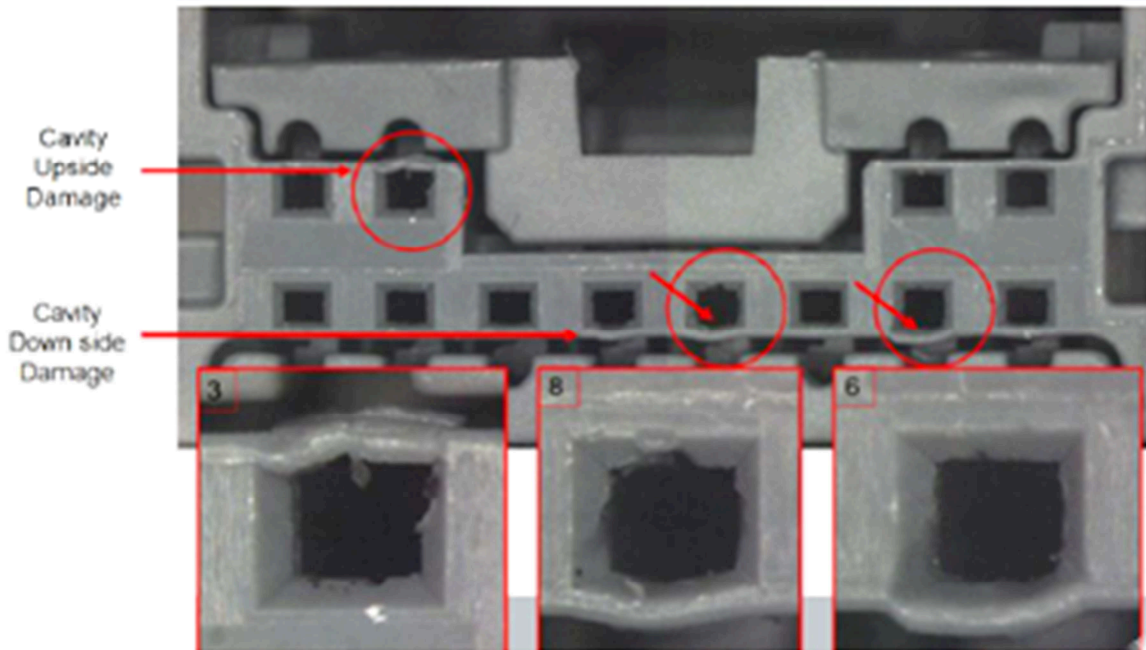

B. Best Practice: DIMENSIONAL VERIFICATION – Reference AS-560023-001 for complete list of requirements.

REVISION: L	ECR/ECN INFORMATION: EC No: DATE:	TITLE: Molex MINI 50 0.50mm Connector System Application Specification	SHEET No. 26 of 27
DOCUMENT NUMBER: AS-34791-020	CREATED / REVISED BY: F. PETIT-PIERRE	CHECKED BY: T. MACHUGA	APPROVED BY: R. BAUMAN
<small>TEMPLATE FILENAME: APPLICATION_SPEC[SIZE_A](V.1).DOC</small>			



APPLICATION SPECIFICATION

The following dimensions must be met as stated in AS-560023-001, and are important to successful performance of the CTX50 terminal/Mini50 connection system.

- Strip length:

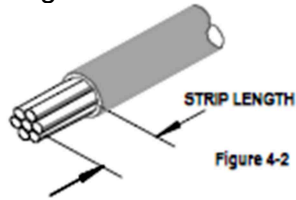

- Conductor crimping height and Width:

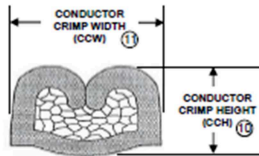

- Wire position:

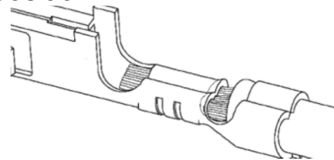

- Bell Mouth:



- Insulation crimping height and Width:

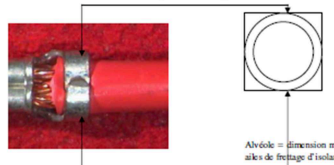

- Bend Up or Down; Twisting or Rolling:

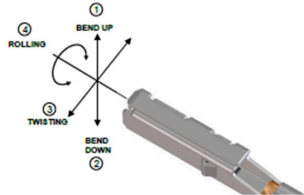

- Bulge:

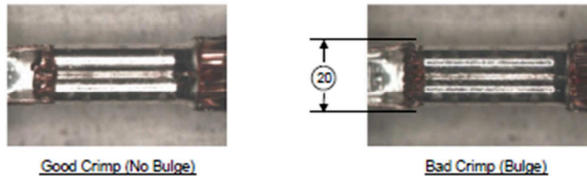

- Tooling must be in good condition

REVISION: L	ECR/ECN INFORMATION: EC No: DATE:	TITLE: Molex MINI 50 0.50mm Connector System Application Specification	SHEET No. 27 of 27
DOCUMENT NUMBER: AS-34791-020	CREATED / REVISED BY: F. PETIT-PIERRE	CHECKED BY: T. MACHUGA	APPROVED BY: R. BAUMAN