



Disea Electronics Co., LTD

An IATF16949 display manufacturing company.
Focus on Industrial &Auto LCD display customized service.

URL:www.diseaelec.com.

E-mail:mkt@diseaelec.com

PRODUCT SPECIFICATIONS

For Customer:_____

: APPROVAL FOR SPECIFICATION

Customer Model No. _____

: APPROVAL FOR SAMPLE

Module No.: ZW-T070BAHA-83CP-B

 Date : 2022-09-22

Table of Contents

No.	Item	Page
1	Cover Sheet(Table of Contents)	P1
2	Revision Record	P2
3	General Specifications	P3
4	Outline Drawing	P4
5	Absolute Maximum Ratings	P5
6	Electrical Specifications and Instruction Code	P6-P7
7	Optical Characteristics	P8-P11
8	Reliability Test Items and Criteria	P12
9	Precautions for Use of LCD Modules	P13-P14

For Customer's Acceptance:

Approved By	Comment

PREPARED	CHECKED	VERIFIED BY QA DEPT	VERIFIED BY R&D DEPT
SSX			

2. Revision Record

Date	Rev.No.	Page	Revision Items	Prepared
2022.09.22	V0		The first release	SSX

DISEA CONFIDENTIAL

3. General Specifications

ZW-T070BAHA-83CP-B is a TFT-LCD module. It is composed of a TFT-LCD panel, driver IC, FPC, a back light and CTP unit. The 7.0" display area contains 1024x(RGB)x600 pixels and can display up to 16.7M colors. This product accords with RoHS environmental criterion.

Item	Contents	Unit	Note
LCD Type	TFT	-	
Display color	16.7M		1
Viewing Direction	ALL	O'Clock	
Operating temperature	-20~+70	°C	
Storage temperature	-30~+80	°C	
Module size	165.30X121.00X7.42	mm	2
Active Area(W×H)	154.21X85.92	mm	
Number of Dots	1024X600	dots	
Controller	HX8282A11+HX8696A	-	
CTP driver	ILI2511		
Power Supply Voltage	5V(HDMI)/5V(USB CTP)	V	
Backlight	3S8P-LEDs (white)	pcs	
Weight	---	g	
Interface	HDMI for LCM and USB for CTP	-	

Note 1: Color tune is slightly changed by temperature and driving voltage.

Note 2: Without FPC and Solder. With CTP.

4.Outline.Drawing

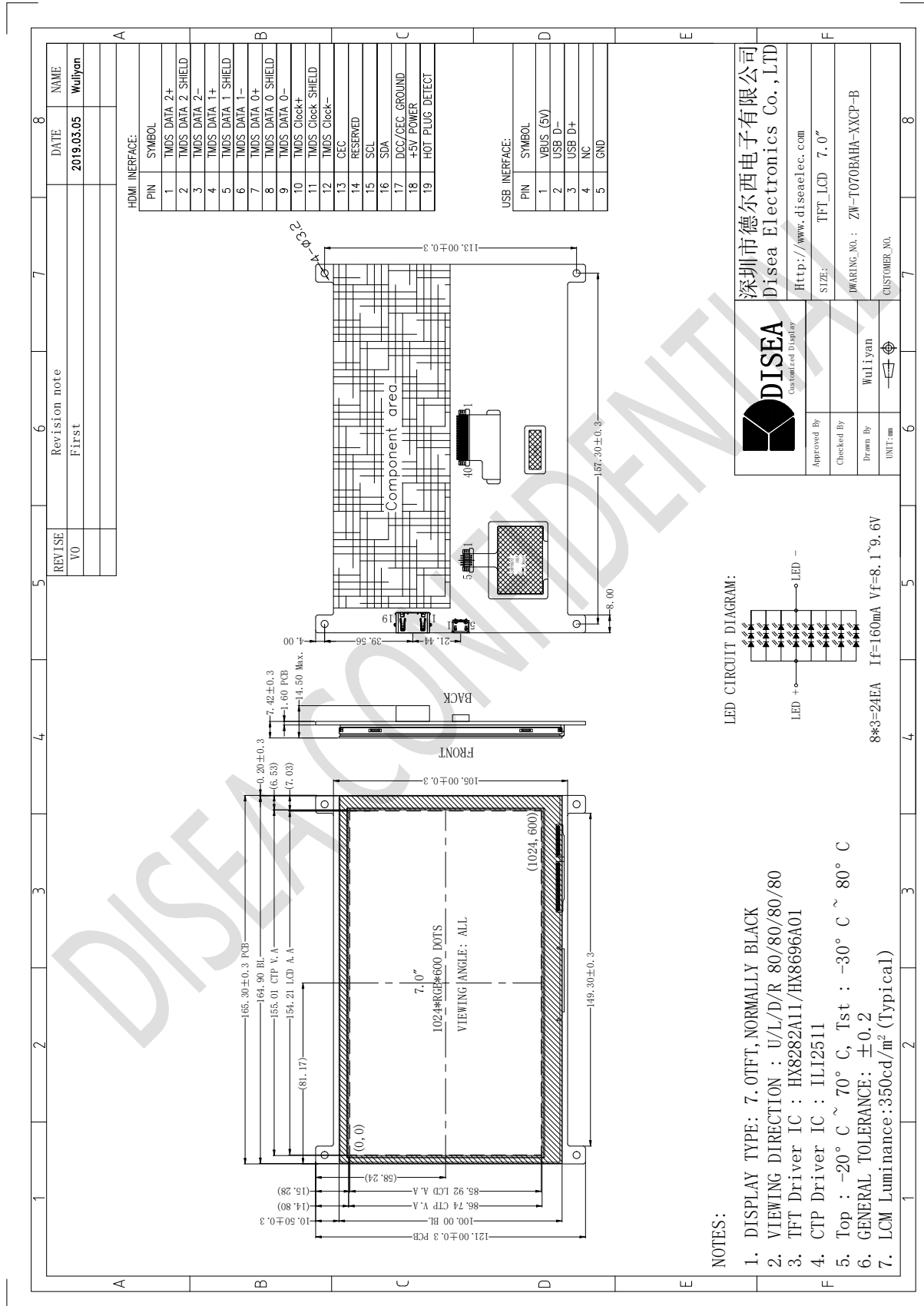

5. Absolute Maximum Ratings(Ta=25°C)

5.1 Electrical Absolute Maximum Ratings.(Vss=0V ,Ta=25°C)

Item	Symbol	Min.	Max.	Unit	Note
Power Supply Voltage	VDD	-0.3	6.0	V	1,2
	VCC	-0.3	13.0	V	1,2
	VBUSIN	-0.3	6.0	V	1,2

Notes:

1. If the module is above these absolute maximum ratings. It may become permanently damaged. Using the module within the following electrical characteristic conditions are also exceeded, the module will malfunction and cause poor reliability.
2. $V_{DD} > V_{SS}$ must be maintained.

5.2 Environmental Absolute Maximum Ratings.

Item	Storage		Operating		Note
	MIN.	MAX.	MIN.	MAX.	
Ambient Temperature	-30°C	80°C	-20°C	70°C	1,2
Humidity	-	-	-	-	3

1. The response time will become lower when operated at low temperature.
2. Background color changes slightly depending on ambient temperature.
The phenomenon is reversible.
3. $T_a \leq 40^\circ\text{C}$:85%RH MAX.

$T_a \geq 40^\circ\text{C}$:Absolute humidity must be lower than the humidity of 85%RH at 40°C.

6. Electrical Specifications and Instruction Code

6.1 Electrical characteristics(V_{SS}=0V ,T_a=25°C)

Parameter	Symbol	Condition	Min	Typ	Max	Unit	
Power supply	V _{DD} (HDMI)	T _a =25°C	4.5	5.0	5.5	V	
Power supply	V _{BUSIN} (CTP)	T _a =25°C	4.5	5.0	5.5	V	
Input voltage	'H'	V _{IH}	V _{DD} (HDMI)=5.0V	0.8*V _{DD}	-	V _{DD}	V
	'L'	V _{IL}	V _{DD} (HDMI)=5.0V	0	-	0.2*V _{DD}	V

6.2 LED backlight specification(V_{SS}=0V ,T_a=25°C)

Item	Symbol	Condition	Min	Typ	Max	Unit	Note
Supply voltage	V _f	I _f =160mA	8.1	9.0	9.9	V	
Uniformity	ΔBp	I _f =160mA	75	80	-	%	
Life Time	time	I _f =160mA	20K	-	-	hours	1

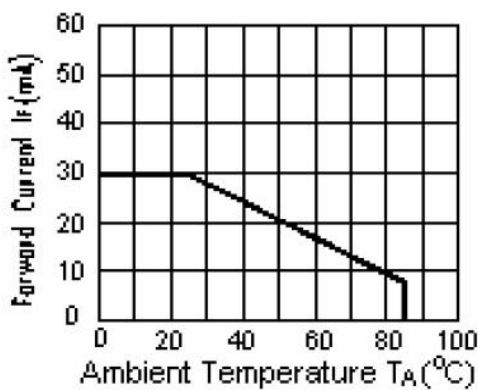

Note 1: Brightness to be decreased to 50% of the initial value at ambient temperature T_A=25 °C

6.3 Interface signals

Pin No.	Symbol	I/O	Function
1	TMDS Data 2+	I	HDMI Data 2+
2	TMDS Data 2 Shield	I	HDMI Data 2 Shield
3	TMDS Data 2-	I	HDMI Data 2-
4	TMDS Data 1+	I	HDMI Data 1+
5	TMDS Data 1 Shield	I	HDMI Data 1 Shield
6	TMDS Data 1-	I	HDMI Data 1-
7	TMDS Data 0+	I	HDMI Data 0+
8	TMDS Data 0 Shield	I	HDMI Data 0 Shield
9	TMDS Data 0-	I	HDMI Data 0-
10	TMDS Clock+	I	HDMI Clock+
11	TMDS Clock Shield	I	HDMI Clock Shield
12	TMDS Clock-	I	HDMI Clock-
13	CEC	I	Consumer Electronics Control
14	NC	-	No Connection
15	SCL	I	Serial clock
16	SDA	I	Serial Input /output data bus
17	DDC/CEC GND	P	DDC/CEC Ground
18	VDD	P	Power Supply +5v
19	HPD	P	Hot Plug Detect

USB PIN:

Pin No.	Symbol	I/O	Function
1	VBUSIN	P	Power supply(+5)
2	USB D-	I	Data -
3	USB D+	I	Data+
4	NC	-	No Connection
5	GND	P	Ground.

7. Optical Characteristics

Item	Symbol	Condition	Min.	Typ.	Max.	Unit	Note	
Brightness	Bp	$\theta=0^\circ$	-	350	-	Cd/m ²	1	
Uniformity	ΔBp	$\Phi=0^\circ$	75	80	-	%	1,2	
Viewing Angle	3:00	Cr \geq 10	-	80	-	Deg	3	
	6:00		-	80	-			
	9:00		-	80	-			
	12:00		-	80	-			
Contrast Ratio	Cr	$\theta=0^\circ$ $\Phi=0^\circ$	500	800	-	-	4	
Response Time	T _r		-	25	40	ms	5	
	T _f	-	-	-	ms			
Color of CIE Coordinate	W	x	$\theta=0^\circ$ $\Phi=0^\circ$	Typ. -0.05	TBD	Typ. +0.05	-	1,6
		y			TBD		-	
	R	x			TBD		-	
		y			TBD		-	
	G	x			TBD		-	
		y			TBD		-	
	B	x			TBD		-	
		y			TBD		-	
NTSC Ratio	S	45	50	-	%			

Note: The parameter is slightly changed by temperature, driving voltage and material

Note 1: The data are measured after LEDs are turned on for 5 minutes. LCM displays full white.

The brightness is the average value of 9 measured spots. Measurement equipment BM-7 (Φ5mm)

Measuring condition:

- Measuring surroundings: Dark room.
- Measuring temperature: Ta=25°C.

- Adjust operating voltage to get optimum contrast at the center of the display.

Measured value at the center point of LCD panel after more than 5 minutes while backlight turning on.

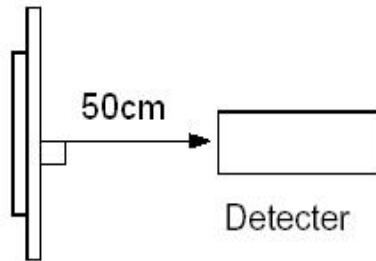

Note 2: The luminance uniformity is calculated by using following formula.

$$\Delta Bp = Bp (\text{Min.}) / Bp (\text{Max.}) \times 100 (\%)$$

$Bp (\text{Max.})$ = Maximum brightness in 9 measured spots

$Bp (\text{Min.})$ = Minimum brightness in 9 measured spots.

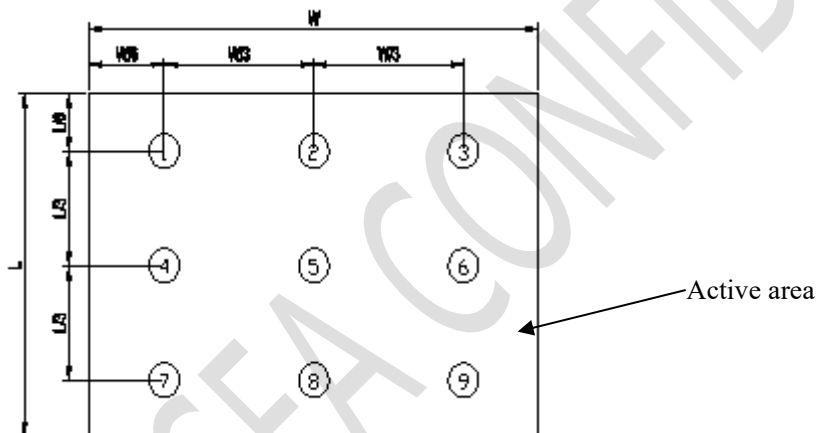

Note 3: The definition of viewing angle:

Refer to the graph below marked by θ and Φ

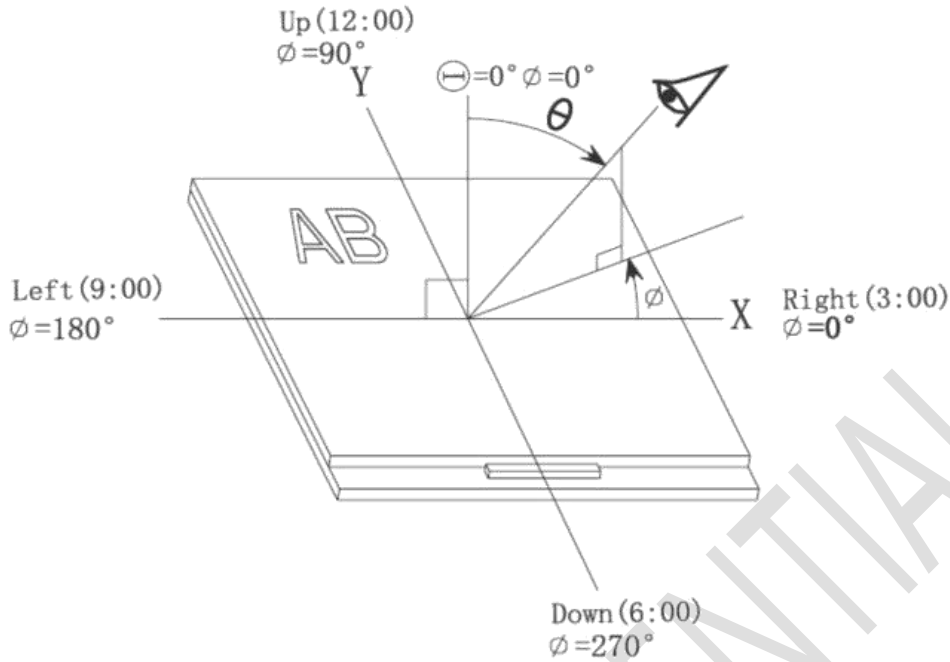

Note 4: Definition of contrast ratio.(Test LCD using DMS501)

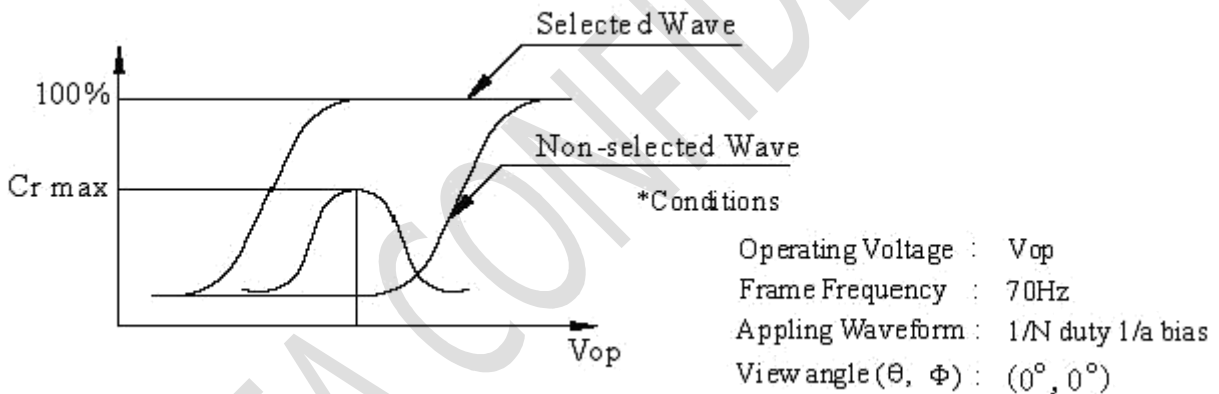

$$\text{Contrast ratio}(Cr) = \frac{\text{Brightness of selected dots}}{\text{Brightness of non-selected dots}}$$

Note 5: Definition of Response time. (Test LCD using DMS501):

The output signals of photo detector are measured when the input signals are changed from “black” to “white”(falling time) and from “white” to “black”(rising time), respectively. The response time is defined as the time interval between the 10% and 90% of amplitudes. Refer to figure as below.

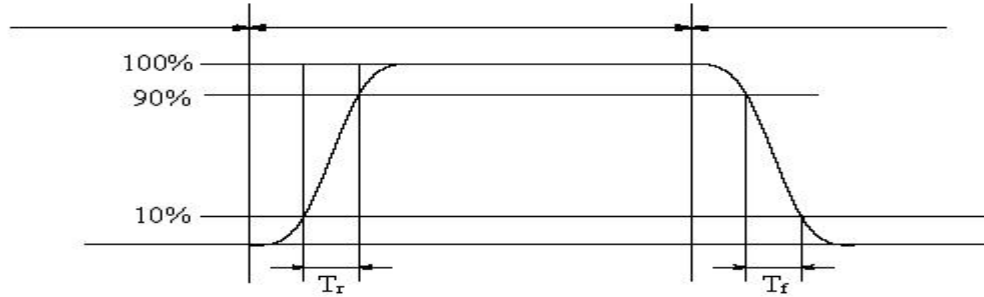

The definition of response time

Note 6: Definition of Color of CIE Coordinate and NTSC Ratio.

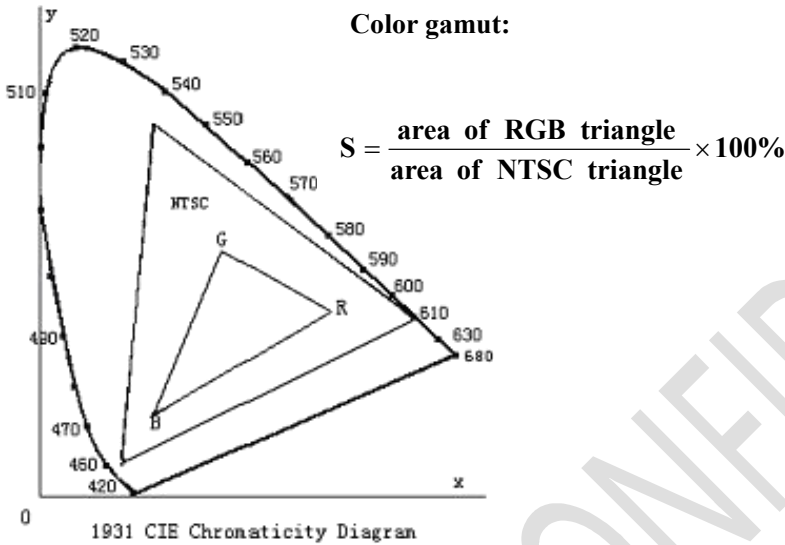

Note 7: Definition of cross talk.

Cross talk ratio(%)=|pattern A Brightness-pattern B Brightness|/pattern A Brightness*100

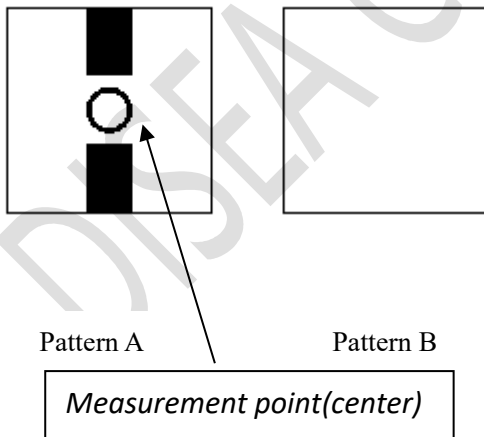

Electric volume value=3F+/-3Hex

8. Reliability Test Items and Criteria

Test Item	Test condition	Remark
High Temperature Storage	Ta = 80°C 96hrs	Note1,Note3,4
Low Temperature Storage	Ta = -30°C 96hrs	Note1,Note3,4
High Temperature Operation	Ta = 70°C 96hrs	Note2,Note3,4
Low Temperature Operation	Ta = -20°C 96hrs	Note1,Note3,4
Operation at High Temperature/Humidity	+60°C, 90%RH 96hrs	Note3,Note4
Thermal Shock	-30°C/30 min ~ +80°C/30 min for a total 10 cycles, Start with cold temperature and end with high temperature.	Note3,Note4
Vibration Test	Frequency range:10~55Hz Stroke:1.5mm Sweep:10Hz~55Hz~10Hz 2 hours for each direction of X. Y. Z. (6 hours for total)	
Mechanical Shock	100G 6ms,±X, ±Y, ±Z 3 times for each direction	
Package Vibration Test	Random Vibration : 0.015G*G/Hz from 5-200HZ, -6dB/Octave from 200-500HZ 2 hours for each direction of X. Y. Z. (6 hours for total)	
Package Drop Test	Height:60cm 1 corner, 3 edges, 6 surfaces	
Electro Static Discharge	±2KV, Human Body Mode, 100pF/1500Ω	

Note 1: Ta is the ambient temperature of samples.

Note 2: Ts is the temperature of panel's surface.

Note 3: In the standard condition, there shall be no practical problem that may affect the display function. After the reliability test, the product only guarantees operation, but don't guarantee all of the cosmetic specification.

Note 4: Before cosmetic and function test, the product must have enough recovery time, at least 2 hours at room temperature

9. Precautions for Use of LCD Modules

9.1 Handling Precautions

9.1.1 The display panel is made of glass. Do not subject it to a mechanical shock by dropping it from a high place, etc.

9.1.2 If the display panel is damaged and the liquid crystal substance inside it leaks out, be sure not to get any in your mouth, if the substance comes into contact with your skin or clothes, promptly wash it off using soap and water.

9.1.3 Do not apply excessive force to the display surface or the adjoining areas since this may cause the color tone to vary.

9.1.4 The polarizer covering the display surface of the LCD module is soft and easily scratched. Handle this polarizer carefully.

9.1.5 If the display surface is contaminated, breathe on the surface and gently wipe it with a soft dry cloth. If still not completely clear, moisten cloth with one of the following solvents:

— Isopropyl alcohol — Ethyl alcohol

Solvents other than those mentioned above may damage the polarizer. Especially, do not use the following:

— Water — Ketone — Aromatic solvents

9.1.6 Do not attempt to disassemble the LCD Module.

9.1.7 If the logic circuit power is off, do not apply the input signals.

9.1.8 To prevent destruction of the elements by static electricity, be careful to maintain an optimum work environment.

- a. Be sure to ground the body when handling the LCD Modules.
- b. Tools required for assembly, such as soldering irons, must be properly ground.
- c. To reduce the amount of static electricity generated, do not conduct assembly and other work under dry conditions.
- d. The LCD Module is coated with a film to protect the display surface. Be care when peeling off this protective film since static electricity may be generated.

9.2 Storage precautions

9.2.1 When storing the LCD modules, avoid exposure to direct sunlight or to the light of fluorescent lamps.

9.2.2 The LCD modules should be stored under the storage temperature range. If the LCD modules will be stored for a long time, the recommend condition is:

Temperature : 0°C ~ 40°C

Relatively humidity: ≤80%

9.2.3 The LCD modules should be stored in the room without acid, alkali and harmful gas.

9.3 The LCD modules should be no falling and violent shocking during transportation, and also should avoid excessive press, water, damp and sunshine.

“Disea Electronics Co., Ltd. reserves the right to change this specification.”

ADD: 5F,#3 Building,TianFuAn Industrial park,LeZhuJiao,ZhouShi Road,
XiXiang Town,BaoAn District,ShenZhen City,GuangDong Province,China

URL:<http://www.diseaelec.com>

- END