

SPS

The SPS product family is specially designed for an off line SMPS with minimal external component. The SPS consist of high voltage Power SenseFET and current mode PWM IC. Included control IC features a tr-immed oscillator, under voltage lock out, leading edge blanking, optimized gate turn-on/turn-off driver, thermal shut down protection, over voltage protection, and temperature compensated precision current source for loop compensation and fault protection circuitry. Compared to discrete MOSFET and controller or RCC switching converter solution, a SPS can reduce total component count, design size, weight and at the same time increase efficiency, productivity and system reliability. It has a basic platform well suited for cost effective monitor power supply.

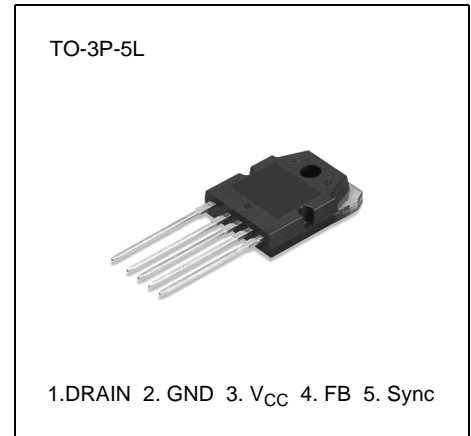

FEATURES

- Wide operating frequency range up to 150kHz
- Pulse by pulse over current limiting
- Over load protection
- Over voltage protection (Min. 23V)
- Internal thermal shutdown function
- Under voltage lockout
- Internal high voltage sense FET
- External sync terminal
- Latch up Mode

ORDERING INFORMATION

Device	Package	Rating	Topr (°C)
KA2S0880	TO-3P-5L	800V, 8A	-25°C to +85°C

BLOCK DIAGRAM

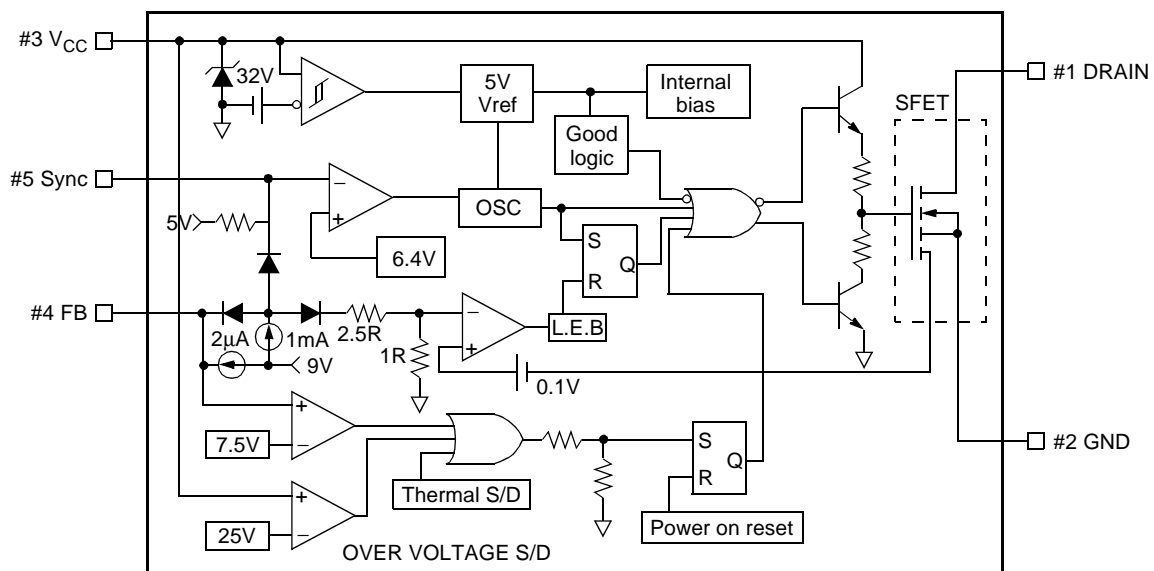

ABSOLUTE MAXIMUM RATINGS

Characteristic	Symbol	Value	Unit
Drain-source (GND) voltage ⁽¹⁾	V_{DSS}	800	V
Drain-Gate voltage ($R_{GS}=1M\Omega$)	V_{DGR}	800	V
Gate-source (GND) voltage	V_{GS}	± 30	V
Drain current pulsed ⁽²⁾	I_{DM}	32.0	A_{DC}
Single pulsed avalanche energy ⁽³⁾	E_{AS}	810	mJ
Avalanche current ⁽⁴⁾	I_{AS}	25	A
Continuous drain current ($T_C=25^\circ C$)	I_D	8.0	A_{DC}
Continuous drain current ($T_C=100^\circ C$)	I_D	5.6	A_{DC}
Supply voltage	V_{CC}	30	V
Analog input voltage range	V_{FB}	-0.3 to V_{SD}	V
Total power dissipation	P_D (watt H/S)	190	W
	Derating	1.54	$W/^\circ C$
Operating temperature	T_{OPR}	-25 to $+85$	$^\circ C$
Storage temperature	T_{STG}	-55 to $+150$	$^\circ C$

NOTES:

- $T_j=25^\circ C$ to $150^\circ C$
- Repetitive rating: Pulse width limited by maximum junction temperature
- $L=24mH$, $V_{DD}=50V$, $R_G=25\Omega$, starting $T_j=25^\circ C$
- $L=13\mu H$, $V_{DD}=330V$, $T_j=25^\circ C$

ELECTRICAL CHARACTERISTICS (SFET part)

(Ta=25°C unless otherwise specified)

Characteristic	Symbol	Test condition	Min.	Typ.	Max.	Unit
Drain-source breakdown voltage	BV_{DSS}	$V_{GS}=0V, I_D=50\mu A$	800	–	–	V
Zero gate voltage drain current	I_{DSS}	$V_{DS}=\text{Max.}, \text{Rating}, V_{GS}=0V$	–	–	50	μA
		$V_{DS}=0.8\text{Max.}, \text{Rating}, V_{GS}=0V, T_C=125^\circ C$	–	–	200	μA
Static drain-source on resistance ^(note)	$R_{DS(ON)}$	$V_{GS}=10V, I_D=5.0A$	–	1.2	1.5	Ω
Forward transconductance ^(note)	gfs	$V_{DS}=15V, I_D=5.0A$	1.5	2.5	–	mho
Input capacitance	C_{iss}	$V_{GS}=0V, V_{DS}=25V, f=1\text{MHz}$	–	2460	–	μF
Output capacitance	C_{oss}		–	210	–	
Reverse transfer capacitance	C_{rss}		–	64	–	
Turn on delay time	td(on)	$V_{DD}=0.5BV_{DSS}, I_D=8.0A$ (MOSFET switching time are essentially independent of operating temperature)	–	–	90	nS
Rise time	tr		–	95	200	
Turn off delay time	td(off)		–	150	450	
Fall time	tf		–	60	150	
Total gate charge (gate-source+gate-drain)	Qg	$V_{GS}=10V, I_D=8.0A, V_{DS}=0.5BV_{DSS}$ (MOSFET switching time are essentially independent of operating temperature)	–	–	150	nC
Gate-source charge	Qgs		–	20	–	
Gate-drain (Miller) charge	Qgd		–	70	–	

NOTE: Pulse test: Pulse width $\leq 300\mu S$, duty cycle $\leq 2\%$

ELECTRICAL CHARACTERISTICS (Control part)

(Ta=25°C unless otherwise specified)

Characteristic	Symbol	Test condition	Min.	Typ.	Max.	Unit
REFERENCE SECTION						
Output voltage ⁽¹⁾	V _{ref}	Ta=25°C	4.80	5.00	5.20	V
Temperature Stability ⁽¹⁾⁽²⁾	V _{ref} /ΔT	-25°C ≤ Ta ≤ +85°C	-	0.3	0.6	mV/°C
OSCILLATOR SECTION						
Initial accuracy	F _{OSC}	Ta=25°C	18	20	22	kHz
Frequency change with temperature ⁽²⁾	ΔF/ΔT	-25°C ≤ Ta ≤ +85°C	-	±5	±10	%
Sync threshold voltage ⁽³⁾	V _{SYTH}	V _{fb} =5V	6.0	6.4	6.8	V
PWM SECTION						
Maximum duty cycle	D _{max}	-	92	95	98	%
FEEDBACK SECTION						
Feedback source current	I _{FB}	Ta=25°C, V _{fb} =GND	0.7	0.9	1.1	mA
Shutdown delay current	I _{delay}	Ta=25°C, 5V ≤ V _{fb} ≤ V _{SD}	1.4	1.8	2.2	μA
OVER CURRENT PROTECTION SECTION						
Over current protection	I _L (max)	Max. inductor current	4.40	5.00	5.60	A
UVLO SECTION						
Start threshold voltage	V _{th} (H)	-	14	15	16	V
Minimum operating voltage	V _{th} (L)	After turn on	9	10	11	V
TOTAL STANDBY CURRENT SECTION						
Start current	I _{ST}	V _{CC} =14V	0.1	0.3	0.55	mA
Operating supply current (control part only)	I _{OPR}	Ta=25°C	6	12	18	mA
V _{CC} zener voltage	V _Z	I _{CC} =20mA	30	32.5	35	V
SHUTDOWN SECTION						
Shutdown Feedback voltage	V _{SD}	-	6.9	7.5	8.1	V
Thermal shutdown temperature (T _j) ⁽¹⁾	T _{SD}	-	140	160	-	°C
Over voltage protection voltage	V _{OVp}	-	23	25	28	V
SOFT START SECTION						
Soft start current	I _{SS}	Sync & S/S=GND	0.8	1.0	1.2	mA
Soft start voltage	V _{SS}	V _{FB} =2V	4.7	5.0	5.3	V

NOTES:

1. These parameters, although guaranteed, are not 100% tested in production
2. These parameters, although guaranteed, are tested in EDS (wafer test) process
3. The amplitude of the sync. pulse is recommended to be between 2V and 3V for stable sync. function.

TYPICAL PERFORMANCE CHARACTERISTICS

(These characteristic graphs are normalized at Ta=25°C)

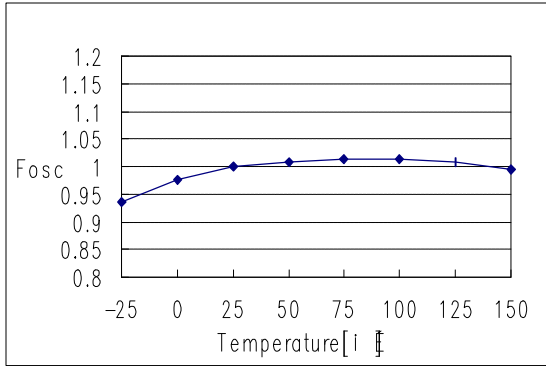

Figure 1. Operating Frequency

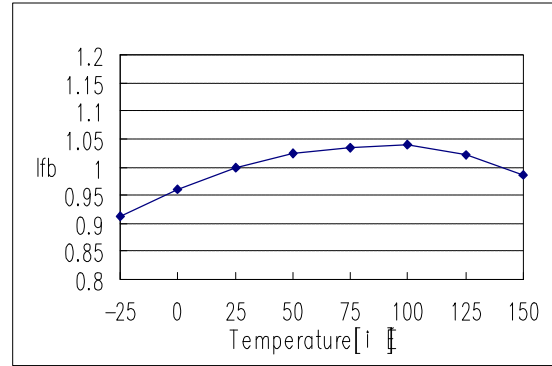

Figure 2. Feedback Source Current

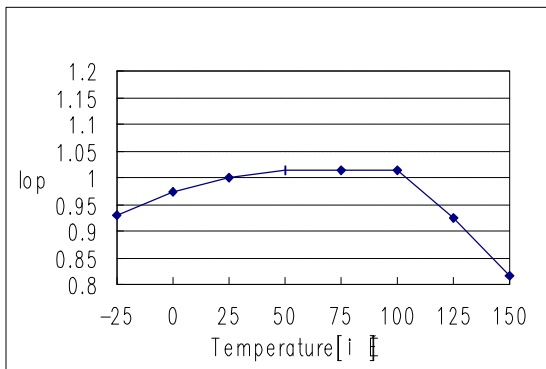

Figure 3. Operating Current

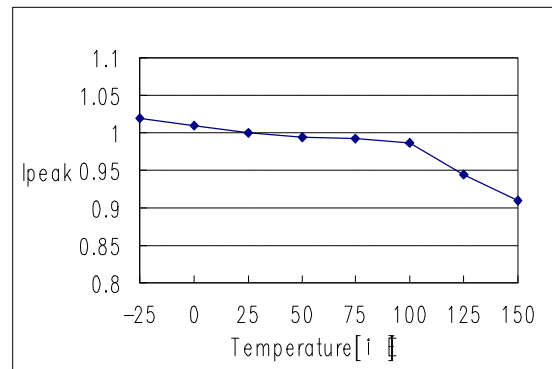

Figure 4. Max. Inductor Current

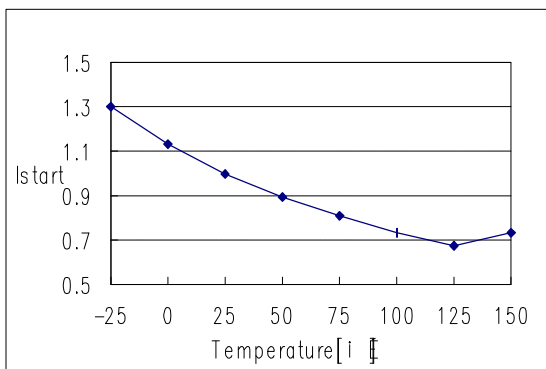

Figure 5. Start up Current

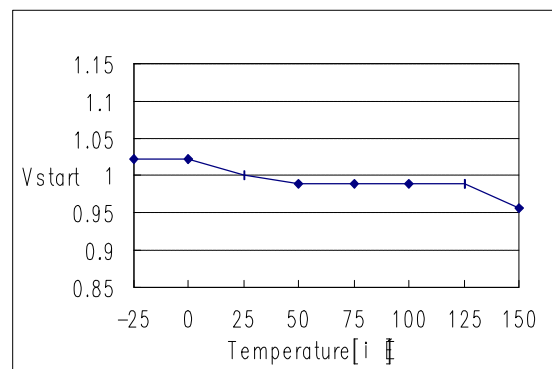

Figure 6. Start Threshold Voltage

TYPICAL PERFORMANCE CHARACTERISTICS (Continued)

(These characteristic graphs are normalized at $T_a=25^\circ\text{C}$)

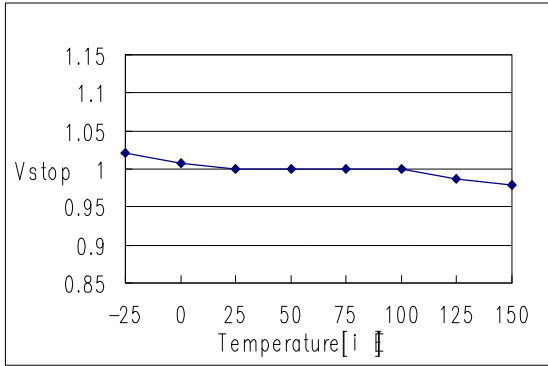

Figure 7. Stop Threshold Voltage

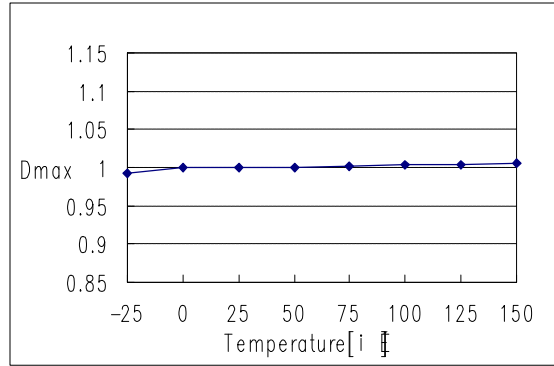

Figure 8. Maximum Duty Cycle

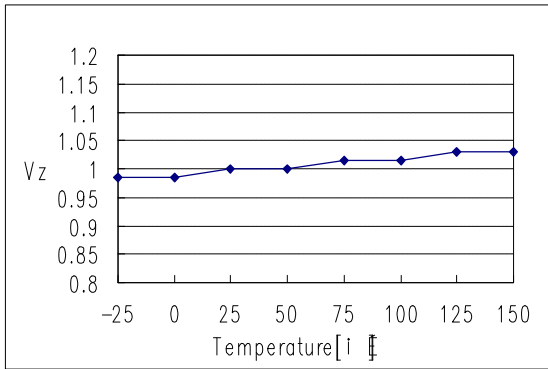

Figure 9. V_{CC} Zener Voltage

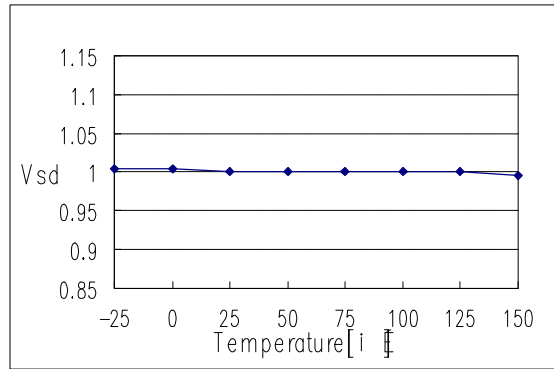

Figure 10. Shutdown Feedback Voltage

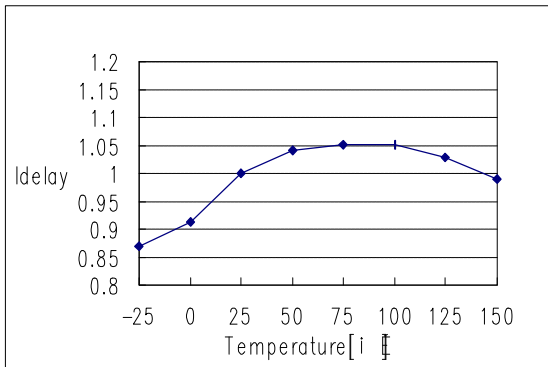

Figure 11. Shutdown Delay Current

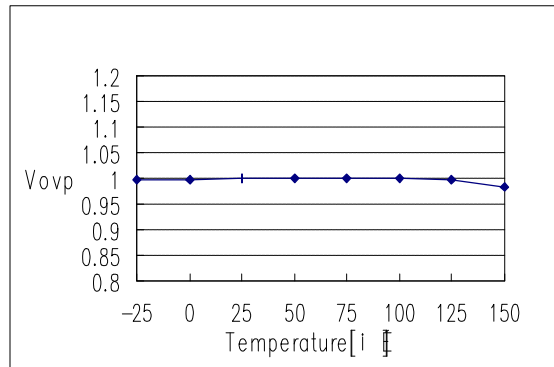

Figure 12. Over Voltage Protection

TYPICAL PERFORMANCE CHARACTERISTICS (Continued)

(These characteristic graphs are normalized at $T_a=25^\circ\text{C}$)

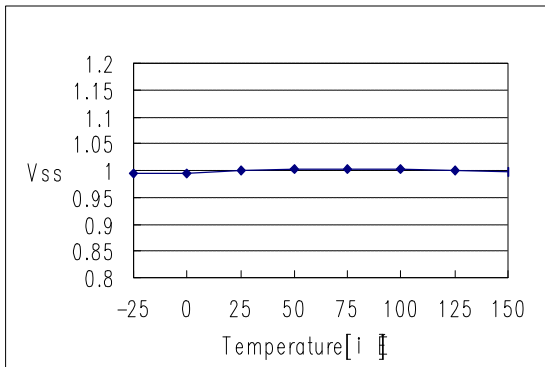

Figure 13. Soft Start Voltage

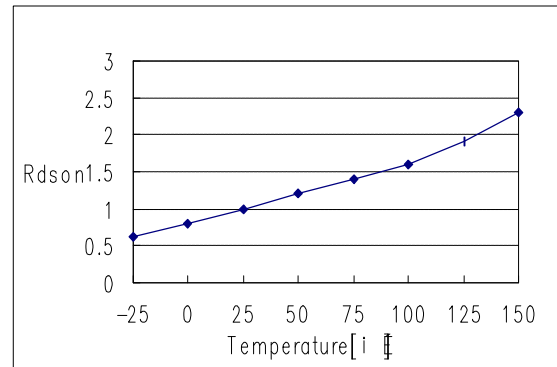

Figure 14. Drain Source Turn-on Resistance

TRADEMARKS

The following are registered and unregistered trademarks Fairchild Semiconductor owns or is authorized to use and is not intended to be an exhaustive list of all such trademarks.

ACEx™	ISOPLANAR™	UHC™
CoolFET™	MICROWIRE™	VCX™
CROSSVOLT™	POP™	
E ² CMOS™	PowerTrench™	
FACT™	QST™	
FACT Quiet Series™	Quiet Series™	
FAST®	SuperSOT™-3	
FASTr™	SuperSOT™-6	
GTO™	SuperSOT™-8	
HiSeC™	TinyLogic™	

DISCLAIMER

FAIRCHILD SEMICONDUCTOR RESERVES THE RIGHT TO MAKE CHANGES WITHOUT FURTHER NOTICE TO ANY PRODUCTS HEREIN TO IMPROVE RELIABILITY, FUNCTION OR DESIGN. FAIRCHILD DOES NOT ASSUME ANY LIABILITY ARISING OUT OF THE APPLICATION OR USE OF ANY PRODUCT OR CIRCUIT DESCRIBED HEREIN; NEITHER DOES IT CONVEY ANY LICENSE UNDER ITS PATENT RIGHTS, NOR THE RIGHTS OF OTHERS.

LIFE SUPPORT POLICY

FAIRCHILD'S PRODUCTS ARE NOT AUTHORIZED FOR USE AS CRITICAL COMPONENTS IN LIFE SUPPORT DEVICES OR SYSTEMS WITHOUT THE EXPRESS WRITTEN APPROVAL OF FAIRCHILD SEMICONDUCTOR CORPORATION. As used herein:

1. Life support devices or systems are devices or systems which, (a) are intended for surgical implant into the body, or (b) support or sustain life, or (c) whose failure to perform when properly used in accordance with instructions for use provided in the labeling, can be reasonably expected to result in significant injury to the user.
2. A critical component is any component of a life support device or system whose failure to perform can be reasonably expected to cause the failure of the life support device or system, or to affect its safety or effectiveness.

PRODUCT STATUS DEFINITIONS

Definition of Terms

Datasheet Identification	Product Status	Definition
Advance Information	Formative or In Design	This datasheet contains the design specifications for product development. Specifications may change in any manner without notice.
Preliminary	First Production	This datasheet contains preliminary data, and supplementary data will be published at a later date. Fairchild Semiconductor reserves the right to make changes at any time without notice in order to improve design.
No Identification Needed	Full Production	This datasheet contains final specifications. Fairchild Semiconductor reserves the right to make changes at any time without notice in order to improve design.
Obsolete	Not In Production	This datasheet contains specifications on a product that has been discontinued by Fairchild semiconductor. The datasheet is printed for reference information only.